

LINEAR INTEGRATED CIRCUITS

TYPES SN56514, SN76514 BALANCED MIXERS

BULLETIN NO. DLS 7371430, JANUARY 1971 - REVISED SEPTEMBER 1973

- Flat Response to 100 MHz
- Local Oscillator IF Isolation . . . 30 dB Typ
- Local Oscillator RF Isolation . . . 60 dB Typ
- RF-IF Isolation . . . 30 dB Typ
- Conversion Gain . . . 14 dB Typ
- Use with 12-V or +6-V Power Supplies

description

The SN56514 and SN76514 are doubly balanced mixers which utilize two cross-coupled, differential transistor pairs driven by a third balanced pair. The circuit features a flat response over a wide band of frequencies. The SN56514 is characterized for operation over the full military temperature range of -55°C to 125°C , the SN76514 is characterized for operation from 0°C to 70°C .

schematic

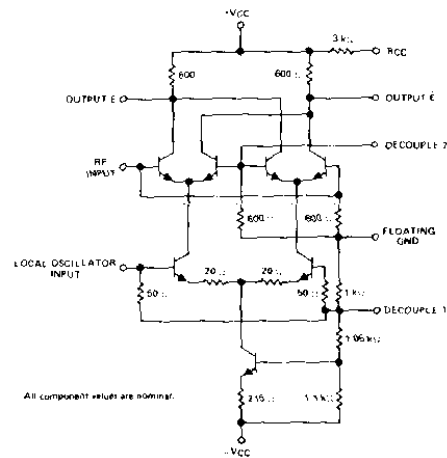

7

terminal assignments

J OR N DUAL-IN-LINE PACKAGE
(TOP VIEW)

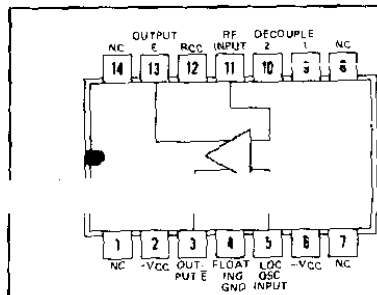

L PLUG-IN PACKAGE
(TOP VIEW)

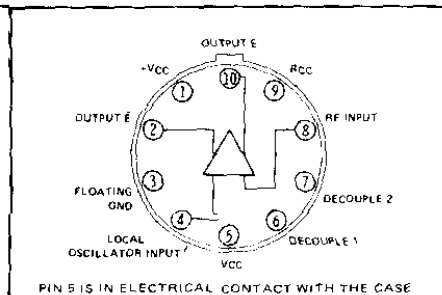

For operation from a single 12-V supply, connect the positive terminal of the supply to +V_{CC}, the negative terminal to -V_{CC}, and the floating-ground terminal to R_{CC}. For operation from two 6-V supplies, leave R_{CC} open and connect the positive terminal of one supply to +V_{CC}, the negative terminal of the other supply to -V_{CC}, and the remaining terminals of the two supplies to the floating-ground terminal. See Figure 19.

NC: No internal connection

TYPES SN56514, SN76514 BALANCED MIXERS

absolute maximum ratings over operating free-air temperature range (unless otherwise noted)

Supply voltage, V_{CC} (see Note 1)	18 V
Input voltage (see Notes 1 and 2)	7 V
Continuous output current (see Note 3)	10 mA
Continuous total power dissipation at (or below) 25°C free-air temperature (see Note 4)	500 mW
Operating free-air temperature range: SN56514 Circuits	-55°C to 125°C
SN76514 Circuits	0°C to 70°C
Storage temperature range	-65°C to 150°C

recommended operating conditions

	MIN	NOM	MAX	UNIT
Supply voltage, V_{CC}		12		V
Local oscillator input voltage (see Note 5)		250	300	mV rms
RF input voltage (see Note 5)		10	30	mV rms
Operating free-air temperature range: SN56514 Circuits	-55		125	°C
SN76514 Circuits	0		70	°C

7

electrical characteristics at 25°C free-air temperature, $V_{CC} = 12$ V

PARAMETER	TEST FIGURE	TEST CONDITIONS	SN56514			SN76514			UNIT
			MIN	TYP	MAX	MIN	TYP	MAX	
V_O Quiescent output voltage	1		9.6	10.5	11.3	9.6	10.5	11.3	V
I_{CC} Supply current	1		5.5	7.4	10.9	5.5	7.4	10.9	mA
G_C Conversion gain (single-ended output)	2	f_{RF} and $f_{LO} = 100$ kHz thru 40 MHz	15	29†			29†		dB
LO/IF1 Local oscillator to IF isolation	3	$f_{LO} = 100$ kHz thru 40 MHz	40	52†			52†		dB
RF/IF1 RF to IF isolation	4	$f_{RF} = 100$ kHz thru 40 MHz	15	28†			28†		dB

†The typical values are at 40 MHz.

- NOTES: 1. All d-c voltage values are with respect to $-V_{CC}$ terminal.
 2. This rating applies to the local oscillator input, RF input, and Decouple 2.
 3. This value applies for both outputs simultaneously.
 4. For operation above 25°C free-air temperature, refer to Dissipation Derating Curve, Figure 18.
 5. All signal voltages are with respect to the floating-ground terminal. Alternatively, the RF input may be applied differentially between the RF input terminal and Decouple 2.

TYPES SN56514, SN76514 BALANCED MIXERS

PARAMETER MEASUREMENT INFORMATION

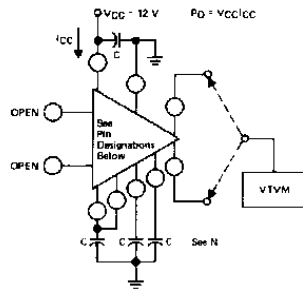

FIGURE 1— V_{CC} , I_{CC} , and P_D

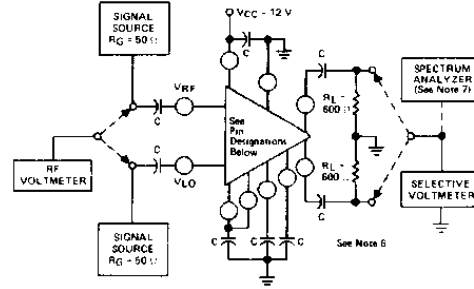

FIGURE 2— G_c

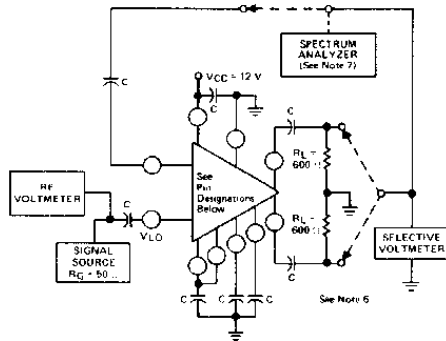

FIGURE 3— $LOFI$ and $LORFI$

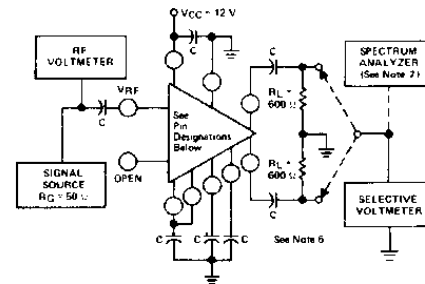
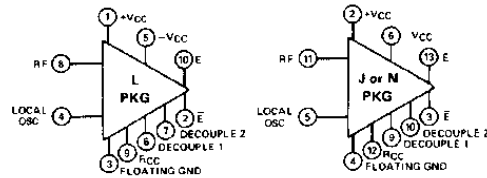

FIGURE 4— $RFIF1$

7

Pin Designations: For all test circuits appearing in this data sheet, terminal functions are defined by their relative positions as shown in the drawings in this block.



- NOTES: 6. Capacitor C comprises the following capacitors in parallel, 1 μF , 0.1 μF , and 0.0015 μF .
7. The spectrum analyzer is used for frequencies above the normal range of the selective voltmeter.

TYPES SN56514, SN76514 BALANCED MIXERS

TYPICAL CHARACTERISTICS

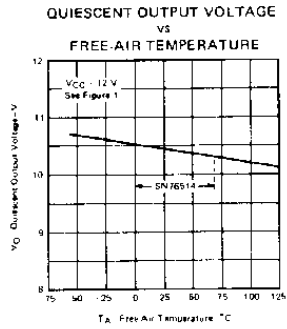

FIGURE 5

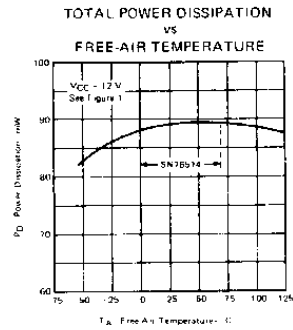

FIGURE 6

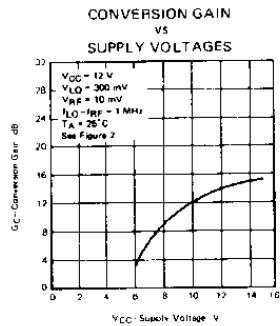

FIGURE 7

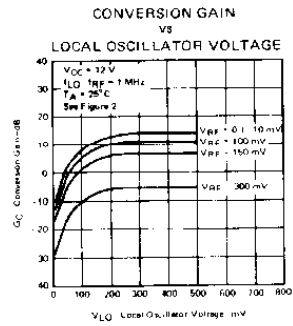

FIGURE 8

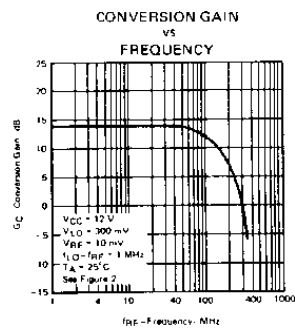

FIGURE 9

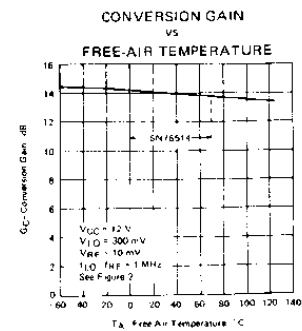

FIGURE 10

7

TYPES SN56514, SN76514 BALANCED MIXERS

TYPICAL CHARACTERISTICS

LOCAL OSCILLATOR TO IF ISOLATION
VS
FREQUENCY

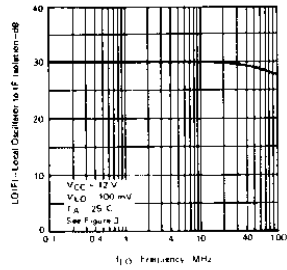

FIGURE 11

LOCAL OSCILLATOR TO IF ISOLATION
VS
FREE-AIR TEMPERATURE

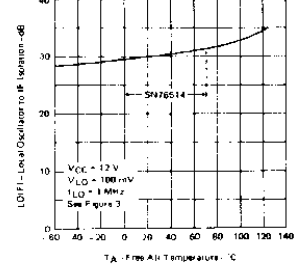

FIGURE 12

LOCAL OSCILLATOR TO RF ISOLATION
VS
FREQUENCY

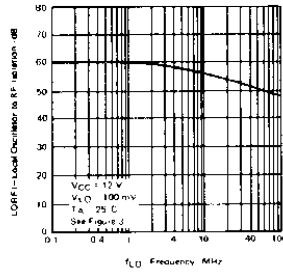

FIGURE 13

LOCAL OSCILLATOR TO RF ISOLATION
VS
FREE-AIR TEMPERATURE

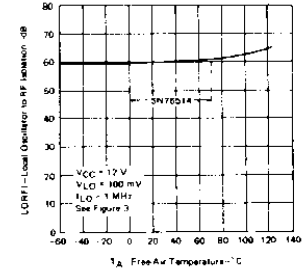

FIGURE 14

RF TO IF ISOLATION
VS
FREQUENCY

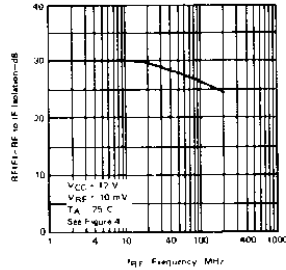

FIGURE 15

RF TO IF ISOLATION
VS
FREE-AIR TEMPERATURE

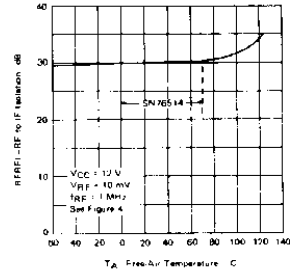
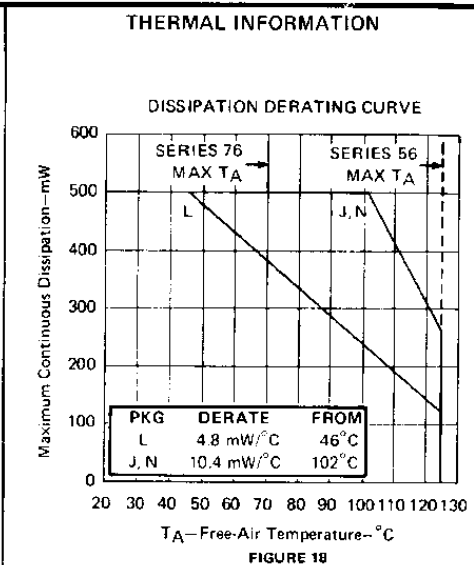
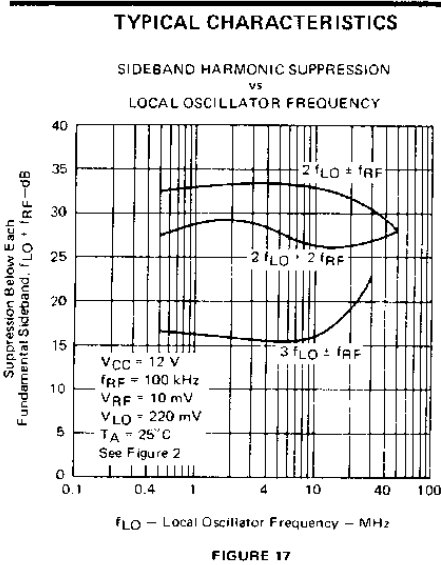

FIGURE 16

7

BALANCED MIXERS



7

TYPICAL APPLICATION DATA

The SN56514 and SN76514 balanced mixers are designed to have considerable circuit flexibility which results in a wide range of applications. Typical applications include use as balanced modulators for sideband-suppressed-carrier generation, product detectors for demodulation, frequency converters, and frequency or phase modulators. In addition, the SN56514 and SN76514 may be used in control systems and analog computers as low-level multipliers or squaring circuits.

The circuits are designed to operate from either a single 12-V supply or two 6-V supplies. Electrical characteristics will be unchanged with the use of either power supply option. External bypass capacitors, as shown in Figure 19, should be used for optimum performance.

The mixer's electrical performance and the inherent IC advantages of size, reliability and component matching make it very desirable for use in communication and control systems.

