

# ST-S370

## SERVICE MANUAL

*AEP Model*  
*UK Model*



### SPECIFICATIONS

#### FM tuner

Frequency range	87.5 - 108 MHz		
Antenna terminals	75 ohms unbalanced		
Intermediate frequency	10.7 MHz		
Sensitivity	at 26 dB quieting, mono 10.3 dBf, 0.9 $\mu$ V/75 ohms at 46 dB quieting, stereo 38.5 dBf, 23 $\mu$ V/75 ohms		
Signal-to-noise ratio (at 40 kHz deviation)	80 dB (mono) 76 dB (stereo)		
Harmonic distortion	WIDE	0.04 % (mono) 0.05 % (stereo)	
	NARROW	0.06 % (mono) 0.08 % (stereo)	
Separation	50 dB (at 1 kHz)		
Selectivity	at 400 kHz	WIDE	80 dB
		NARROW	90 dB
	at 300 kHz	WIDE	45 dB
		NARROW	70 dB
Output	400 mV, (at 40 kHz deviation)		

#### AM tuner

Frequency range	Except Italian model: MW: 531 - 1,602 kHz (9 kHz step) LW: 153 - 279 kHz (1 kHz step) Italian model: MW: 522 - 1,611 kHz (9 kHz step) LW: 144 - 288 kHz (1 kHz step)	
Intermediate frequency	450 kHz	
Usable sensitivity	MW: AM loop antenna 300 $\mu$ V/m LW: AM loop antenna 1 mV/m	
Signal-to-noise ratio	54 dB	
Harmonic distortion	0.3 %	
Selectivity	32 dB	

#### General

Power requirements	UK model : 240 V AC, 50/60 Hz AEP, Germany, Italian model : 220 - 230 V AC, (or 240 V AC adjustable by authorized Sony personnel), 50/60 Hz
Power consumption	14 W
Dimensions	Approx. 430 x 85 x 295 mm (w/h/d) (17 x 3 3/8 x 11 5/8 inches)
Weight	Approx. 3.2 kg (7 lb 1oz)
Accessories supplied	Remote control cord (1) Connecting cord (1) AM loop antenna (1)

Design and specifications subject to change without notice.

**FM STEREO / FM-AM TUNER**  
**SONY®**



**TABLE OF CONTENTS**

<u>Section</u>	<u>Title</u>	<u>Page</u>
Specification.....		1
<b>1. GENERAL</b> .....		<b>3</b>
<b>2. ADJUSTMENTS</b> .....		<b>8</b>
<b>3. DIAGRAMS</b>		
3-1. Block Diagram .....		11
3-2. Printed Wiring Boards.....		15
3-3. Schematic Diagram .....		17
<b>4. EXPLODED VIEW</b> .....		<b>23</b>
<b>5. ELECTRICAL PARTS LIST</b> .....		<b>24</b>

**MODEL IDENTIFICATION**

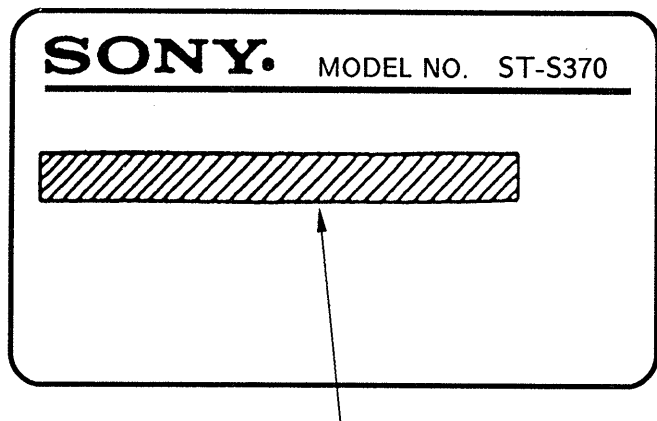
*- Specification Label -*



**SAFETY-RELATED COMPONENT WARNING!!**  
 COMPONENTS IDENTIFIED BY MARK  OR DOTTED LINE WITH MARK  ON THE SCHEMATIC DIAGRAMS AND IN THE PARTS LIST ARE CRITICAL TO SAFE OPERATION. REPLACE THESE COMPONENTS WITH SONY PARTS WHOSE PART NUMBERS APPEAR AS SHOWN IN THIS MANUAL OR IN SUPPLEMENTS PUBLISHED BY SONY.

**AEP, Germany,**

**Italian Model : AC 220 - 230V 50/60Hz**

**UK Model : AC 240V 50/60Hz**

# SECTION 1 GENERAL

This section is extracted from instruction manual.

## Connections

- Connect the AC power cord last. Make sure power is off.
- Cord plugs and jacks are color coded. Red plugs and jacks are for right channel (R) and white ones for left channel (L).
- Fully insert cable connectors into jacks. Loose connections may cause hum or noise.
- Keep the speaker cords, connecting cord and power cord away from the AM loop antenna or antenna lead-in of the tuner to avoid possible noise pickup

## Connexions

- Le cordon d'alimentation secteur doit être raccordé en dernier. Vérifier que l'appareil est hors tension.
- Les fiches et les prises sont codées par couleur. Les fiches et prises rouges sont destinées au canal droit (R) et les fiches et prises blanches, au canal gauche (L).
- Insérer les connecteurs des cordons à fond dans les prises, car des connexions relâchées risquent de provoquer un ronronnement ou des parasites.
- Tenir les cordons des enceintes acoustiques, le cordon de liaison et le cordon d'alimentation secteur éloignés de l'antenne cadre AM ou de la descente d'antenne du tuner pour éviter que l'antenne ne capte des parasites.

## Conexiones

- Conecte el cable de alimentación en último lugar. Asegúrese de que la alimentación esté desconectada.
- Las clavijas y tomas de los cables están codificadas en color. Las rojas son para el canal derecho (R) y las blancas para el izquierdo (L).
- Inserte las clavijas completamente en las tomas.
- Las conexiones flojas pueden causar zumbido y ruido.
- Mantenga los cables de los altavoces, el cable conector, y el cable de alimentación lejos de la antena de cuadro de AM o de la acometida de antena del sintonizador a fin de evitar la posible captación de ruido.

## Collegamenti

- Collegare il cavo di alimentazione per ultimo. Assicurarsi che l'apparecchio sia spento.
- Le spine dei cavi e le prese sono codificate con colori diversi. Le spine e le prese rosse sono per il collegamento del canale destro (R) e le spine e le prese bianche sono per il collegamento del canale sinistro (L).
- Inserire a fondo le spine dei cavi nelle prese.
- Collegamenti allentati possono provocare ronzii o rumore.
- Tenere i cavi diffusori, il cavo di collegamento e il cavo di alimentazione lontano dall'antenna AM ad anello o dalla discesa d'antenna del sintonizzatore per evitare possibili interferenze.

FM antenna  
Antenne FM  
Antenna de FM  
Antenna FM

AM loop antenna (supplied)  
Antenne cadre AM (fournie)  
Antenna de cuadro de AM (suministrado)  
Antenna AM ad anello (in dotazione)

For better reception, connect to an outdoor antenna as shown in the right.  
Pour une meilleure réception, connecter une antenne extérieure comme indiqué à gauche.  
Para mejorar la recepción, conecte una antena exterior como se indica a la derecha.  
Per una migliore ricezione, collegare un'antenna esterna come illustrato a destra.

For better reception, extend a 6 to 15-meter insulated wire out of doors.  
Pour une meilleure réception étendre un fil isolé de 6 à 15 mètres à l'extérieur.  
Para mejorar la recepción, extienda un conductor aislado de 6 a 15 metros en exterior.  
Per una migliore ricezione, stendere un filo isolato di 6 - 15 metri all'esterno.

Amplifier  
Amplificateur  
Amplificatore

CONTROL S  
OUT

CONTROL S  
IN

TUNER

ST-S370

OUTPUT

to an AC outlet  
à une prise secteur  
a un tomacorriente de CA  
a una presa CA

Supplied connecting cord  
Cordon de connexion fourni  
Cable conector suministrado  
Cavo di collegamento in dotazione

**CONTROL S connector (with the supplied remote control cord)**  
IN: Connect to the CONTROL S OUT connector of the optional Sony amplifier for whole audio system remote control.  
OUT: Connect to the CONTROL S IN connector of other Sony equipment for whole audio system remote control.

**Note on the CONTROL-S Input**  
To remote control this unit through a receiver or amplifier, connect the input on this unit to the CONTROL-S output on a Sony receiver or amplifier, with a CONTROL-S card. When this connection is used, only remote commands sent through the receiver or amplifier will be executed. The remote sensor on this unit will not function.

**Connecteur CONTROL S (avec le cordon de télécommande fourni)**  
IN: Raccorder au connecteur CONTROL S OUT d'un amplificateur optionnel Sony pour pouvoir piloter toute la chaîne stéréo à distance.  
OUT: Raccorder au connecteur CONTROL S IN d'un autre appareil Sony pour pouvoir piloter toute la chaîne stéréo à distance.

**Remarque sur l'entrée CONTROL-S**  
Pour pouvoir piloter cet appareil à distance depuis un ampli-tuner ou un amplificateur, raccorder l'entrée de cet appareil à la sortie CONTROL-S de l'ampli-tuner ou de l'amplificateur Sony, à l'aide d'un cordon CONTROL-S.  
Lorsque cette connexion est réalisée, seuls les messages de commande à distance envoyés par l'intermédiaire de l'ampli-tuner ou de l'amplificateur seront exécutés. Le récepteur de télécommande infrarouge de cet appareil ne fonctionnera pas.

**Receptor CONTROL S (con el cable de control remoto suministrado)**  
IN: Conéctelo al conector CONTROL S OUT de otro equipo Sony para controlar a distancia todo el audiosistema.  
OUT: Conéctelo al conector CONTROL S IN de otro equipo Sony para controlar a distancia todo el audiosistema.

**Nota sobre la entrada CONTROL-S**  
Para controlar esta unidad a distancia a través de un receptor o un amplificador, conecte la entrada de esta unidad a la salida CONTROL-S de un receptor o un amplificador Sony con un cable CONTROL-S. Cuando emplee esta conexión, solamente se ejecutarán los mandatos procedentes del receptor o el amplificador. El sensor de control remoto de esta unidad no funcionará.

**Commetteur CONTROL S (con il cavo di comando a distanza in dotazione)**  
IN: Collegarlo al connettore CONTROL S OUT di un altro apparecchio Sony per il comando a distanza dell'intero sistema audio.  
OUT: Collegarlo al connettore CONTROL S IN di un altro apparecchio Sony per il comando a distanza dell'intero sistema audio.

**Nota sull'ingresso CONTROL-S**  
Per controllare a distanza questo apparecchio tramite un ricevitore o un amplificatore, collegare l'ingresso su questo apparecchio all'uscita CONTROL-S di un ricevitore o amplificatore Sony, usando un cavo CONTROL-S. Quando si usa questo collegamento, solo i comandi a distanza inviati tramite il ricevitore o l'amplificatore saranno eseguiti. Il sensore di comandi a distanza di questo apparecchio rimane inattivo.

## Parts Identification

## Nomenclature

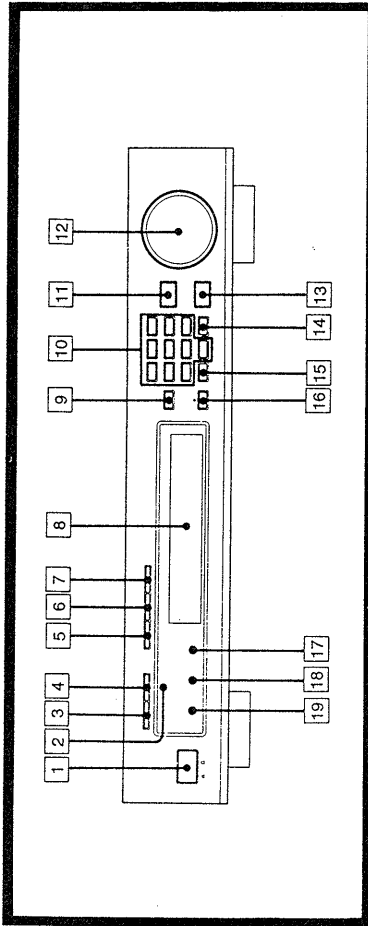

- 1 POWER switch  
 2 WAIT indicator  
 3 RDS button  
 4 AF button  
 5 ANT ATT (antenna attenuator) button  
 6 IF (intermediate frequency) BAND button  
 7 STEREO/MUTE button

**AUTO STEREO/MUTING ON:** Normally, select this mode (by making the MUTING indicator appear and MONO indicators disappear from the display window) when you tune in a strong FM broadcast.

The muting circuit is activated to eliminate interstation noise while tuning so that the FM station is received in stereo mode.

**MONO/MUTING OFF:** Select this position when you tune in a very weak or noisy FM station. Although the sound will come out in monaural, the noise will be greatly reduced. Be sure to keep the sound level of the connected amplifier down to avoid speaker damage caused by interstation noise during tuning.

- 8 Display window  
 9 MEMORY button  
 10 Preset buttons  
 11 TUNING/PRESET button  
 12 TUNING/CHARACTER knob  
 13 DIRECT button  
 14 SHIFT button  
 15 BAND selector  
 16 TUNE MODE button  
 17 DISPLAY MODE button  
 18 DISPLAY button  
 19 CHARACTER button

- 1 Interrupteur d'alimentation (POWER)  
 2 Témoin d'attente (WAIT)  
 3 Touche RDS (Radio Data System)  
 4 Touche de fréquences alternatives (AF)  
 5 Touche d'atténuateur d'antenne (ANT ATT)  
 6 Touche de gamme de fréquence intermédiaire (IF BAND)

**7** Sélecteur de mode de réception FM (STEREO/MUTE)  
**AUTO STEREO/MUTING ON:** En principe, sélectionner ce mode (afficher le témoin MUTEING et éteindre les témoins MONO) lorsqu'une émission FM à signal puissant est accordée. Le circuit de mise en sourdine est alors activé pour éliminer les parasites d'accord de sorte que la station FM peut être captée en mode stéréo.

**MONO/MUTING OFF:** Sélectionner cette position pour accorder une station FM très faible ou qui présente beaucoup d'interférences. L'effet stéréo est éliminé, mais le souffle est considérablement réduit. Maintenir le son de l'amplificateur à un faible niveau pour éviter que les parasites audibles entre les stations, lors de l'accord, endommagent les haut-parleurs.

- 8 Afficheur  
 9 Touche de mémorisation (MEMORY)  
 10 Touches de présélection (PRESET)  
 11 Sélecteur d'accord/présélection (TUNING/PRESET)  
 12 Bouton d'accord/caractères (TUNING/CHARACTER)  
 13 Touche d'accord direct (DIRECT)  
 14 Sélecteur de page de mémoire (SHIFT)  
 15 Sélecteur de gamme de fréquence (BAND)  
 16 Touche de mode d'accord (TUNE MODE)  
 17 Touche de mode d'affichage (DISPLAY MODE)  
 18 Touche d'affichage (DISPLAY)  
 19 Touche de caractères (CHARACTER)

# Receiving Broadcasts

## Tuning in Automatically

Before reception, be sure to connect the AM and FM antenna.

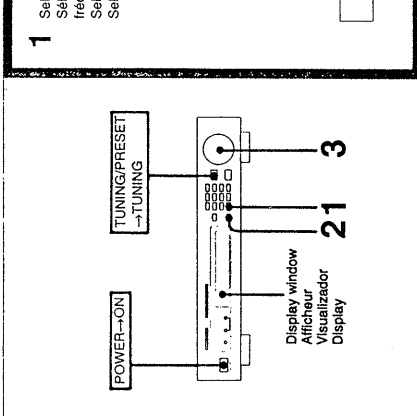

# Réception des émetteurs

## Accord automatique

Avant d'essayer d'accorder une station, ne pas oublier de connecter les antennes AM et FM.

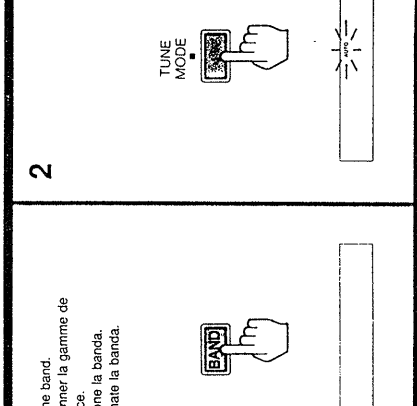

# Radiorricepción

## Sintonia automática

Antes de la recepción, asegúrese de conectar las antenas de AM y FM suministradas.

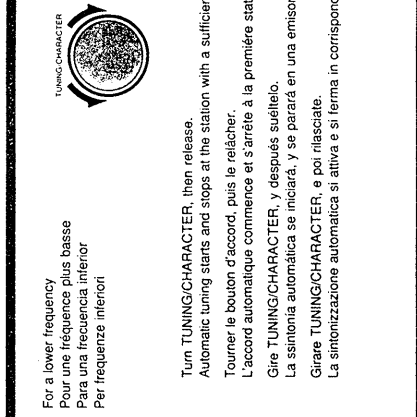

# Ricezione radiofonica

## Sintonia automatica

Prima di usare la radio, assicurarsi di collegare le antenne AM e FM.

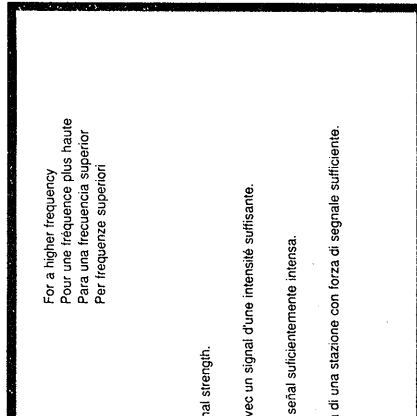

**To receive other stations**  
When the received station is not the one you want, turn TUNING/CHARACTER knob again.

**To receive a strong FM broadcast**  
Normally, set STEREO/MUTE on (press STEREO/MUTE so that the MUTING indicator appears on the display) to reduce noise. Also set to auto stereo mode. The unit operates in the stereo mode for a stereo signal, and automatically switches to the monaural mode for a monaural signal.

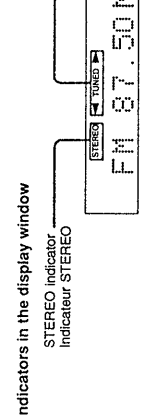

**STEREO indicator:** Lights when an FM stereo program is tuned in.

**Signal indicator:** Indicates the signal strength of the station being received.

**TUNED indicator:** Lights when a station is tuned in accurately.

**Direction indicators:**

- ▲ : Lights when the frequency or the preset number increases.
- ▼ : Lights when the frequency or the preset number decreases.

**Pour capturer d'autres stations**  
Si la station accordée n'est pas celle de votre choix, il suffit de tourner encore une fois le bouton d'accord.

**Réception d'une émission FM à signal puissant**  
En principe, mettre STEREO/MUTE en service (appuyer sur la touche STEREO/MUTE pour afficher le témoin MUTING) pour réduire les parasites. Mettre également le mode stéréo automatique en service. L'appareil fonctionnera alors automatiquement en stéréo lors de la réception d'un signal stéréo et en mono lors de la réception d'un signal mono.

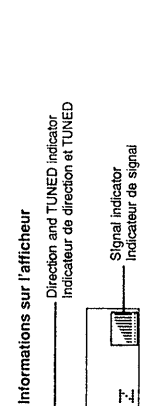

**Indicateur STEREO:** Il s'allume lors de l'accord d'un programme stéréo FM.

**Indicateur de signal:** Il indique l'intensité du signal de la station reçue.

**Indicateur TUNED:** Il s'allume lorsqu'un émetteur est capté avec précision.

**Indicateurs de direction:**

- ▲ : Il s'allume lorsque la fréquence ou le numéro de présélection augmente.
- ▼ : Il s'allume lorsque la fréquence ou le numéro de présélection diminue.

**Para recibir otras emisoras**  
Cuando la emisora recibida no sea la deseada, vuelva a girar TUNING/CHARACTER.

**Para recibir una emisora de FM de señal intensa**  
Normalmente ponga STEREO/MUTE en ON (presión STEREO/MUTE de forma que en el visualizador aparezca el indicador MUTING) a fin de reducir el ruido. Además, establezca el modo de estereo automático. La unidad funcionará en el modo estereo con una señal estereo, y cambiará automáticamente al modo monoaural para una señal monoaural.

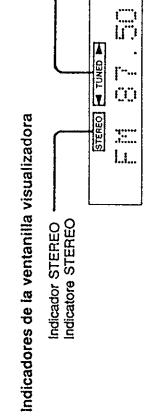

**Indicador STEREO:** Se encenderá cuando se sintonice un programa de FM estereo.

**Indicador de señal:** Mostrará la intensidad de la señal de la emisora que esté recibiendo.

**Indicador TUNED:** Se encenderá cuando se sintonice con precisión una emisora.

**Indicadores de sentido:**

- ▲ : Se encenderá cuando aumente la frecuencia o el número de emisora memorizada.
- ▼ : Se encenderá cuando disminuya la frecuencia o el número de emisora memorizada.

**Per ricevere altre stazioni**  
Se la stazione sintonizzata non è quella desiderata, girare di nuovo la manopola TUNING/CHARACTER.

**Per ricevere una stazione FM dal segnale forte**  
Normalmente attivare STEREO/MUTE (premere STEREO/MUTE in modo che l'indicatore MUTING appaia sul display) per ridurre il rumore. Inoltre regolare il modo di stereo automatico. L'apparecchio funziona in modo stereo per segnali stereo, e passa automaticamente al modo monoaurale per segnali monoaurali.

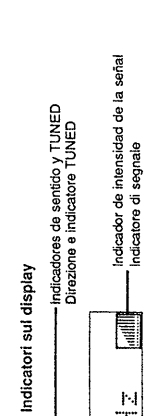

**Indicatore STEREO:** Si illumina quando viene sintonizzata una stazione FM stereo.

**Indicatore di segnale:** Indica la forza di segnale della stazione ricevuta.

**Indicatore TUNED:** Si illumina quando una stazione sintonizzata precisamente.

**Indicatori di direzione:**

- ▲ : Si illumina quando la frequenza o il numero di preselezione aumenta.
- ▼ : Si illumina quando la frequenza o il numero di preselezione diminuisce.



## Receiving Broadcasts

### Receiving RDS (Radio Data System) Service

Some FM stations have started RDS services which is a method to display certain information with the program. By setting the tuner in the RDS mode, you can:

- display the station name and time ... PS (Program Service name), CT (clock time) display service
- receive emergency announcements ... PTY (Program Type) display service
- receive traffic information announcements ... TP (Traffic Program Identification)/TA (Traffic Announcement) service
- Also, you can receive better frequency for your station ... PI (Program Identification) and AF (Alternative Frequency list)

#### To receive display service

When listening to an FM program,  
Press RDS so that "RDS" appears in the window.  
If the station you are receiving is an RDS station, "RDS Service" appears and the station name will be displayed. If the station you are receiving is not an RDS station, "No RDS Signal" will be displayed. In such case,

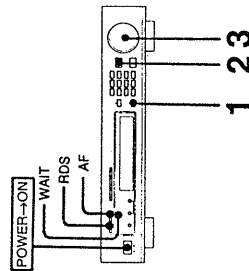

#### 1

Press TUNE MODE so that "AUTO" appears in the window.  
Appuyer sur TUNE MODE de manière à allumer "AUTO" sur l'écran.  
Precion TUNE MODE de forma que en el visualizador aparezca "AUTO".  
Premere TUNE MODE in modo che "AUTO" appaia sul display.

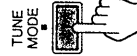

## Réception des émetteurs

### Réception du service RDS (Radio Data System)

Certaines stations FM sont équipés du système RDS qui sert à diffuser et afficher certaines informations en même temps que le programme. Lorsque vous mettez le tuner en mode RDS, vous pouvez:

- affiche le nom de la station et l'heure, des services PS (Program Service name) et CT (Clock Time)
- capter des messages prioritaires ... service PTY
- recevoir des messages d'informations routières ... les services TP (Traffic Program Identification)/TA (Traffic Announcement)
- La meilleure fréquence de la station choisie peut également être captée grâce aux services PI (Program Identification) et AF (Alternative Frequency)

#### Pour recevoir les services RDS

Pendant l'écoute d'un programme FM,  
Appuyez sur RDS de manière à allumer "RDS" sur l'écran.  
Si la station captée est une station RDS, l'indication "RDS Service" est affichée ainsi que le nom de la station. Si la station n'a pas de service RDS, "No RDS Signal" est affiché. Dans ce cas,

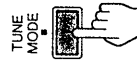

#### 2

Press TUNING/PRESET so that "TUNING" appears.  
Presione TUNING/PRESET de forma que en el visualizador aparezca "TUNING".  
Appuyer sur TUNING/PRESET pour allumer "TUNING".  
Premere TUNING/PRESET in modo che appaia "TUNING".

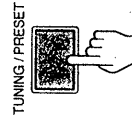

## Radiofreccepción

### Recepción del servicio del sistema de datos por radio (RDS)

Algunas emisoras de FM han iniciado la emisión de servicios del sistema RDS, que es un método de visualizar cierta información con el programa. Si pone el sintonizador en el modo RDS, podrá:

- visualizar el nombre de la emisora y la hora ... Servicio de visualización de PS (nombre del servicio del programa), de visualización de CT (hora)
- recibir anuncios de emergencia ... Servicio de visualización de PTY (tipo de programa)
- recibir anuncios sobre el tráfico ... Servicio de visualización de TP (identificación de programa sobre tráfico)/TA (anuncios sobre el tráfico)
- Además, usted podrá recibir la mejor frecuencia de su emisora ... PI (identificación de programa) y AF (lista de frecuencias alternativas)

#### Para recibir el servicio de visualización

Cuando esté escuchando un programa de FM,  
Presione RDS de forma que en el visualizador aparezca "RDS".  
Si la emisora que esté recibiendo es del sistema RDS, aparecerá "RDS Service" e se visualizá el nombre de la misma. Si la emisora que está recibiendo no es del sistema RDS, se visualizará "No RDS Signal". En tal caso,

## Ricezione radiofonica

### Ricezione del servizio RDS (Radio Data System)

Alcune stazioni FM hanno dato inizio al servizio RDS, che un metodo per visualizzare determinate informazioni contemporaneamente alla trasmissione del programma. Regolando il sintonizzatore nel modo RDS, possibile:

- visualizzare il nome della stazione e l'orario ... PS (Servizio del nome di programma), CT (orario)
- ricevere annunci di emergenza ... Servizio di visualizzazione PTY (tipo di programma)
- Servizio di ricezione di notizie sul traffico ... TP (Identificazione di programmi sul traffico)/TA (Notiziari sul traffico)
- Inoltre, è possibile ricevere la migliore frequenza per la stazione desiderata ... Funzioni PI (identificazione programmi) e AF (Lista di frequenze alternative)

#### Per ricevere il servizio di visualizzazione

Durante l'ascolto di un programma FM,  
Premere RDS in modo che "RDS" appaia sul display. Se la stazione che si sta ricevendo è una stazione RDS, appare "RDS Service" e il nome della stazione verrà visualizzato. Se la stazione che si sta ricevendo non è una stazione RDS, verrà visualizzato "No RDS Signal". In questo caso,

#### 3

Turn the TUNING knob  
Tourner le bouton d'accord.  
Gire el mando TUNING/CHARACTER.  
Girare la manopola TUNING.



The tuner will search for other RDS station and first station name will be displayed.  
Le tuner recherche une autre station RDS et le nom de la première station apparaît sur l'écran.  
El sintonizador buscará otras emisoras y visualizará la primera del sistema RDS.  
Il sintonizzatore ricerca altre stazioni RDS e il nome della prima stazione viene visualizzato.

## SECTION 2 ADJUSTMENTS

• Refer to Adjustment Location on page 10.

Note: As a front-end (FE101, 421 etc.) is difficult to repair if faulty, replace it with new one.

### FM SECTION

• Standard Setting of FM Stereo RF Signal Generator.

STEREO STANDARD SIGNAL	MONAURAL STANDARD SIGNAL
Carrier frequency : 98MHz Modulation : Audio 1kHz, 40kHz deviation Subchannel 38kHz, 40kHz deviation Pilot 19kHz, 7.5kHz deviation	98MHz 1kHz, 40kHz deviation

#### FM Discriminator Adjustment (NULL and MONO Distortion)

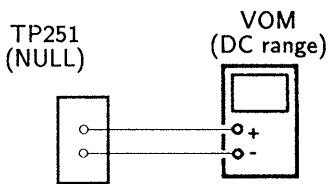
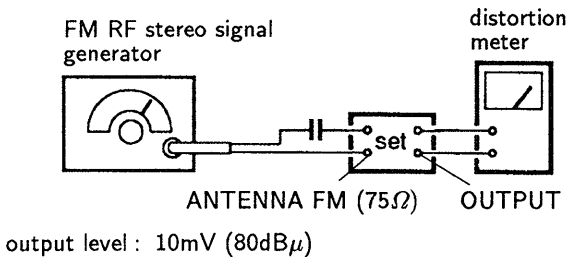

Procedure :

1. Tune the set to 98MHz.
2. Adjust T252 for 0V reading on the VOM.  
..... NULL
3. Adjust T253 for a minimum reading on the distortion meter. .... MONO Distortion
4. Repeat the adjustments of 2 and 3 several times.

Note : When replacing the ceramic filter, perform this alignment.

#### FM Muting Level Adjustment

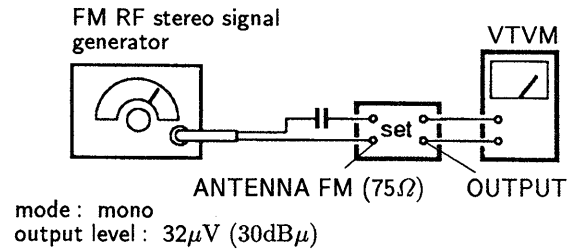

Procedure :

1. Tune the set to 98MHz.
2. Push the MUTING switch and put on the light the "MUTING" indicator in the fluorescent display.
3. Set SSG output level to 32 $\mu$ V (30dB $\mu$ ).
4. Adjust RV251 so that the reading of VTVM becomes within 25 $\mu$ V (28dB $\mu$ ) - 40 $\mu$ V (32dB $\mu$ ).



### FM Signal Level Adjustment

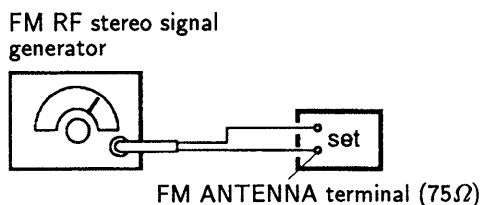

modulation : no modulation  
output level : 10mV (80dBμ)

#### Procedure :

1. Tune the set to 98MHz.
2. Push the display button to change the display mode for signal strength indication.
3. Adjust RV221 to the place where level 10 in the signal strength bar indicator lights and "75dB" indication lights on fluorescent tube.

### FM Narrow Gain Adjustment

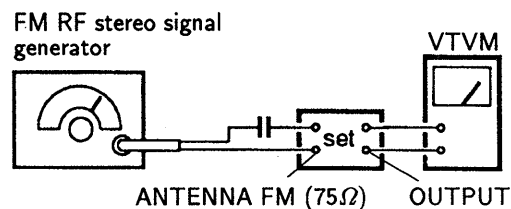

mode : mono  
output level : 32μV (30dBμ)

#### Procedure :

1. Tune the set to 98MHz.
2. Push the IF BAND switch and put on the light the "NARROW" indicator in the fluorescent display.
3. Set SSG output level to 32μV (30dBμ).
4. Adjust RV231 so that the reading on VTVM becomes within 25μV (28dBμ) – 40μV (32dBμ).

### FM Stereo Separation Adjustment

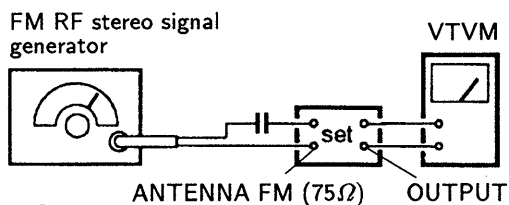

mode : Stereo  
output level : 10mV (80dBμ)

#### Procedure :

FM stereo signal generator output channel	VTVM connection	VTVM reading (dB)
L-CH	L-CH	Ⓐ
R-CH	L-CH	Ⓑ <sup>ⓑ</sup> Adjust RV301 minimum reading.
R-CH	R-CH	Ⓒ
L-CH	R-CH	Ⓓ <sup>Ⓓ</sup> Adjust RV301 for minimum reading.

L-CH Stereo separation : Ⓐ – Ⓑ

R-CH Stereo separation : Ⓒ – Ⓓ

The separation of both channels should be equal.

### RDS, BPF Adjustment

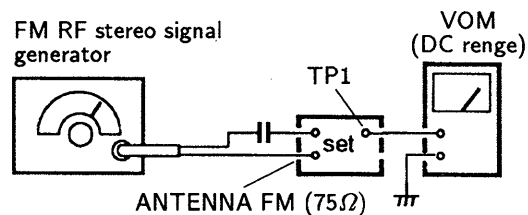

output level : 10mV (80dBμ)  
RDS Modulation : 2kHz deviation

#### Procedure :

1. Turn RV801 to counterclockwise (left) and set the level below 0.5dB than maximum reading on the VOM. (refer to below drawing.)

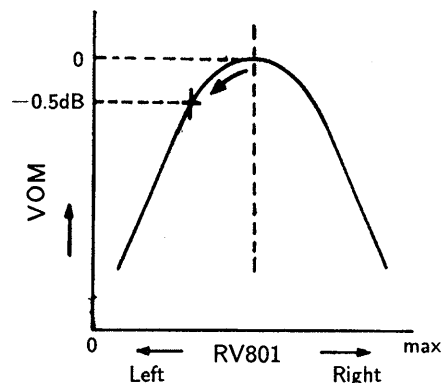

## AM SECTION

## AM Signal Level Adjustment

### Procedure :

1. Set SSG output level so that antenna input level of the set becomes 5.0mV (74dBμ/m).
2. Adjust RV402 to the place where level 10 in the signal strength indicator turns from dark to light.

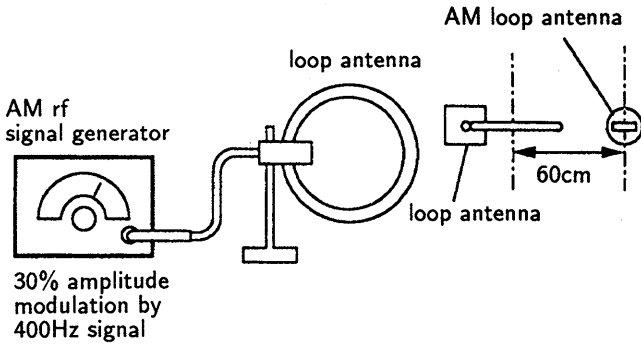

Carrier frequency : 216kHz (LW Band)

AM loop antenna

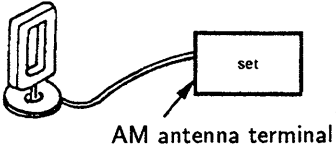

$$\text{dB}\mu/\text{m} = (\text{SSG output level}) - 26\text{dB}$$

## Adjustment Location

- TUNER BOARD -

(Component Side)

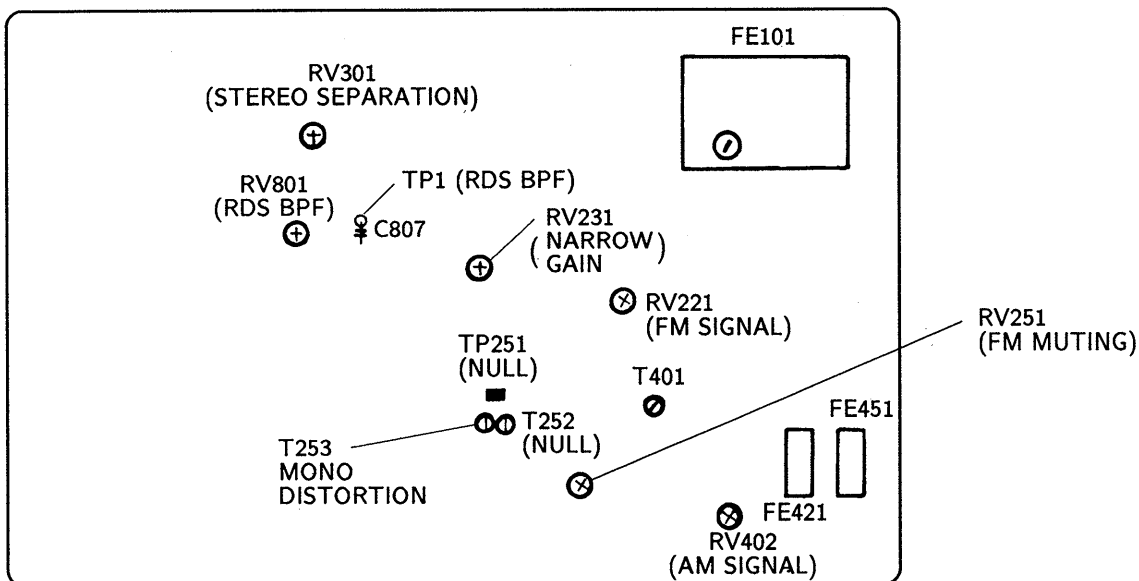

SECTION 3  
DIAGRAMS

3-1. BLOCK DIAGRAM

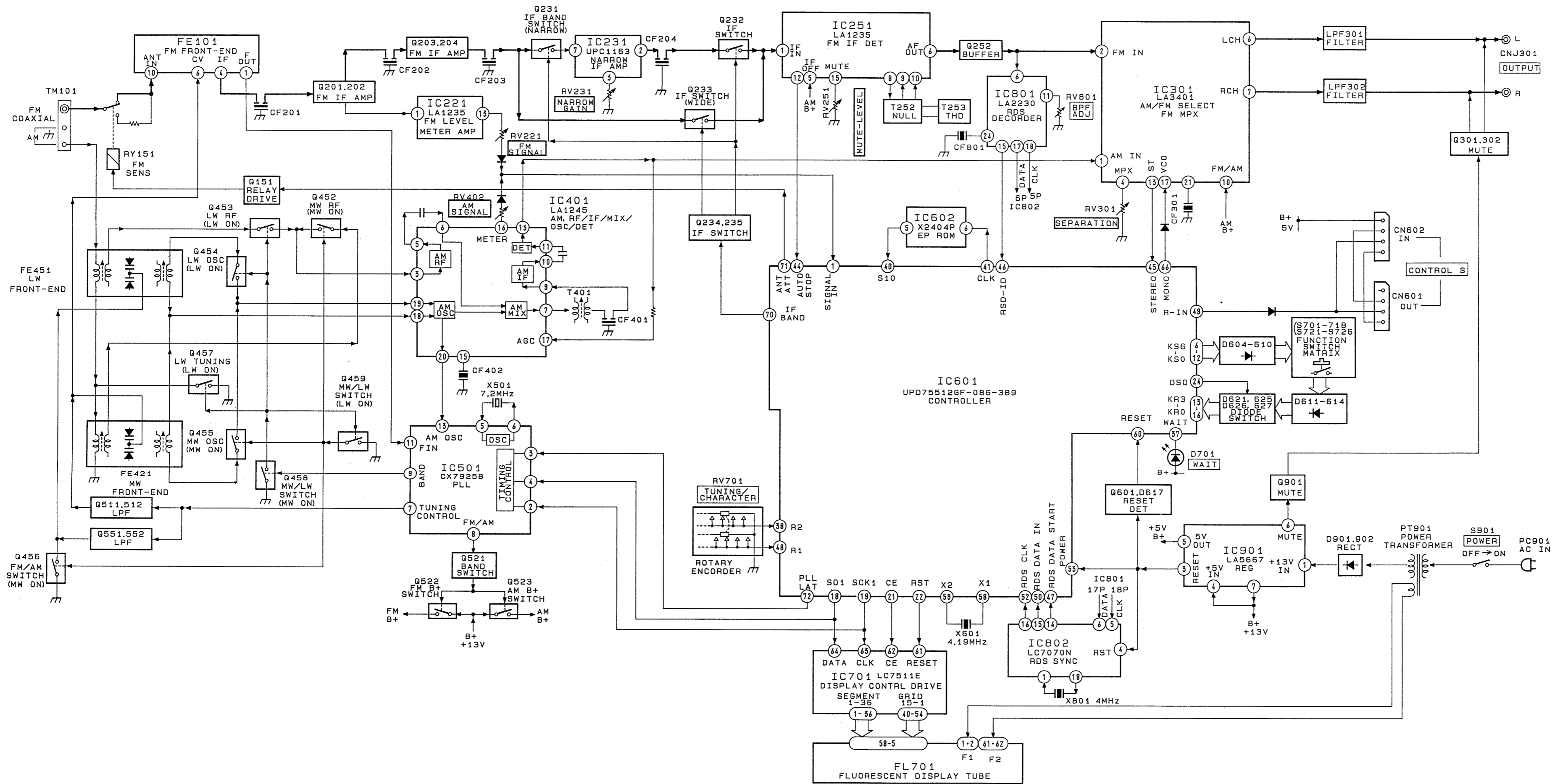

• SEMICONDUCTOR LEAD LAYOUTS

LA5667 2SC3112-B

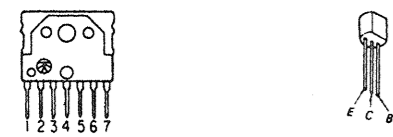

LC75711E 2SK246-GR3

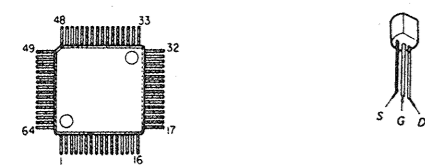

μ PD75512GF-086-3B9 HZS27-2L

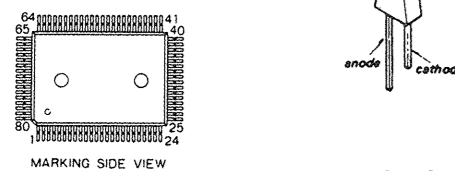

DTA144ES  
DTC144ES  
2SC2603-EF  
2SC2669-OY  
2SC3623A-LK  
2SC3860-TP



DTC114TS  
2SA1175-HFE



• SEMICONDUCTOR LOCATION

Ref. No.	Location	Ref. No.	Location
D151	D-3	Q151	D-3
D221	F-6	Q201	E-6
D301	B-10	Q202	E-6
D402	H-9	Q203	E-7
D601	I-9	Q204	E-7
D602	H-9	Q231	E-8
D604	I-9	Q232	E-8
D605	I-9	Q233	E-8
D606	I-9	Q234	F-8
D607	I-9	Q235	F-8
D608	I-9	Q252	G-8
D609	I-10	Q301	B-9
D610	I-10	Q302	B-8
D611	I-10	Q452	G-4
D612	I-10	Q453	G-4
D613	I-10	Q454	H-4
D614	I-10	Q455	H-4
D615	B-12	Q456	H-2
D616	G-11	Q457	G-3
D617	G-10	Q458	I-4
D618	F-11	Q459	H-4
D621	I-11	Q511	D-3
D701	K-14	Q512	D-2
D901	B-7	Q521	D-4
D902	B-7	Q522	D-4
D903	B-6	Q523	D-5
D904	B-6	Q551	E-3
D905	B-5	Q552	E-2
D906	H-13	Q601	G-10
		Q901	B-7
IC221	F-6		
IC231	D-8		
IC251	G-7		
IC301	C-10		
IC401	H-5		
IC501	E-4		
IC601	H-10		
IC602	H-11		
IC701	L-10		
IC801	E-10		
IC802	F-10		
IC901	C-7		

Note :

- : parts extracted from the component side.
- : indicates side identified with part number.
- ▨ : Pattern on the side which is seen.
- IT : Italian

3-2. PRINTED WIRING BOARDS

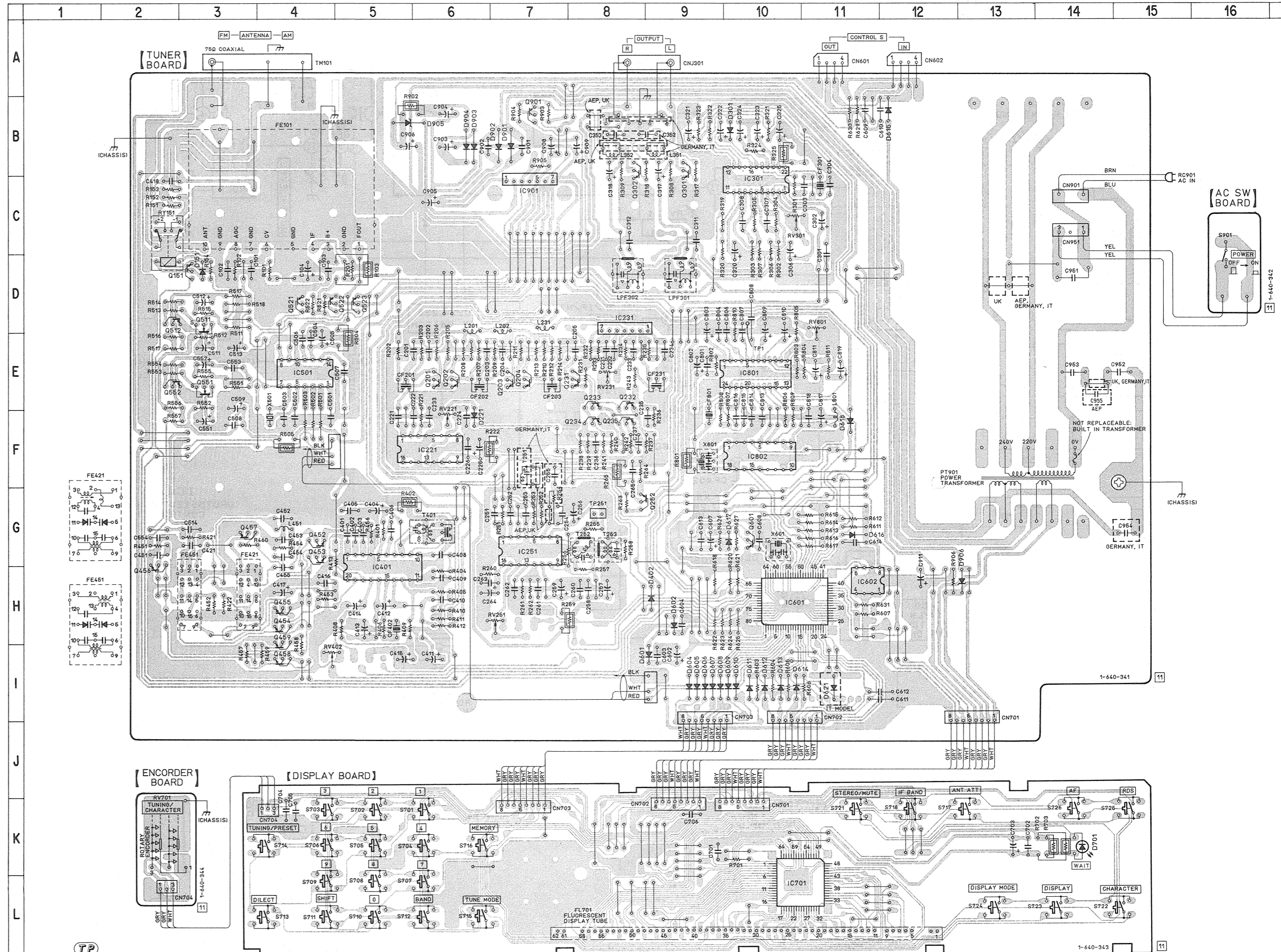

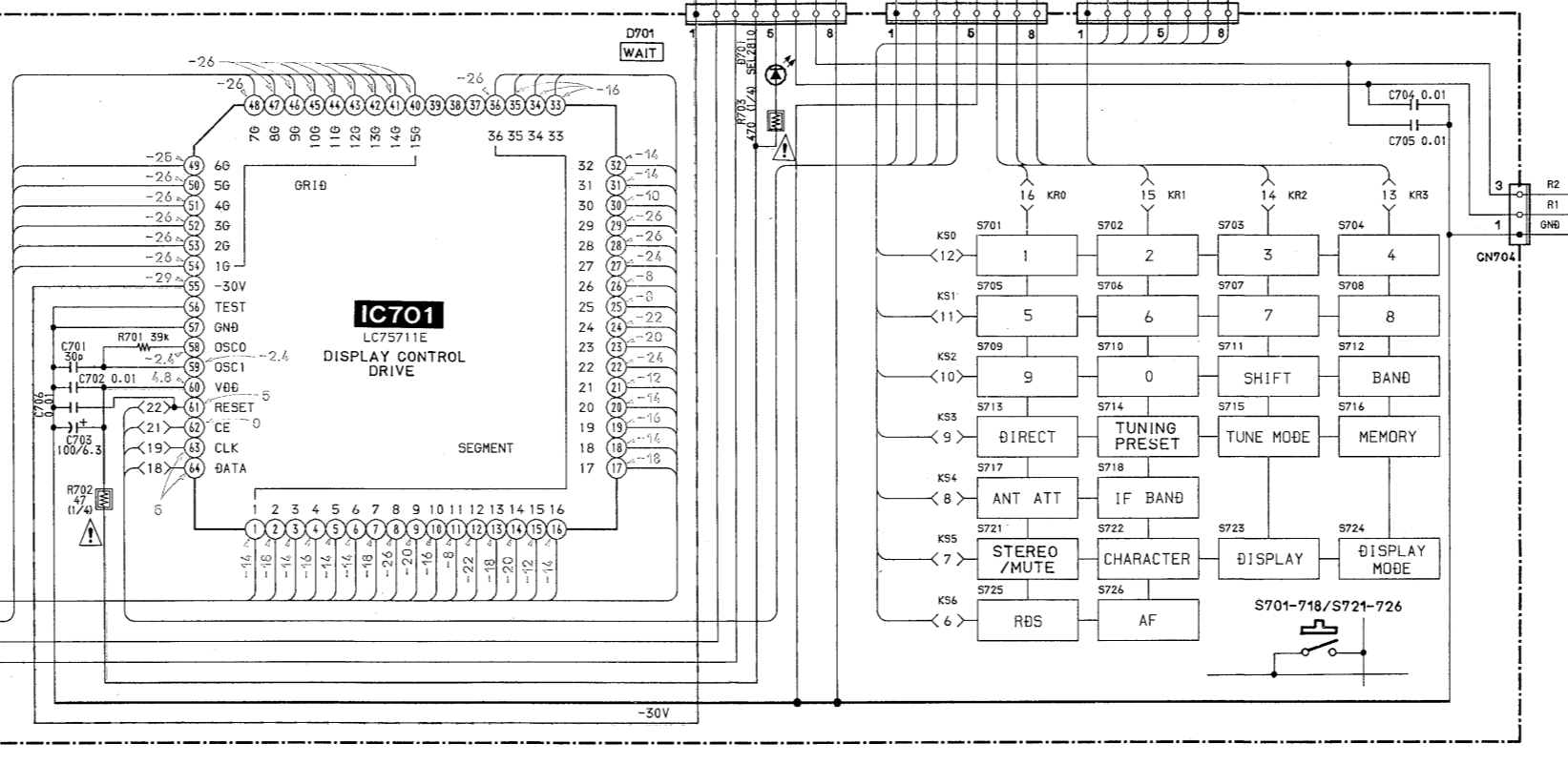
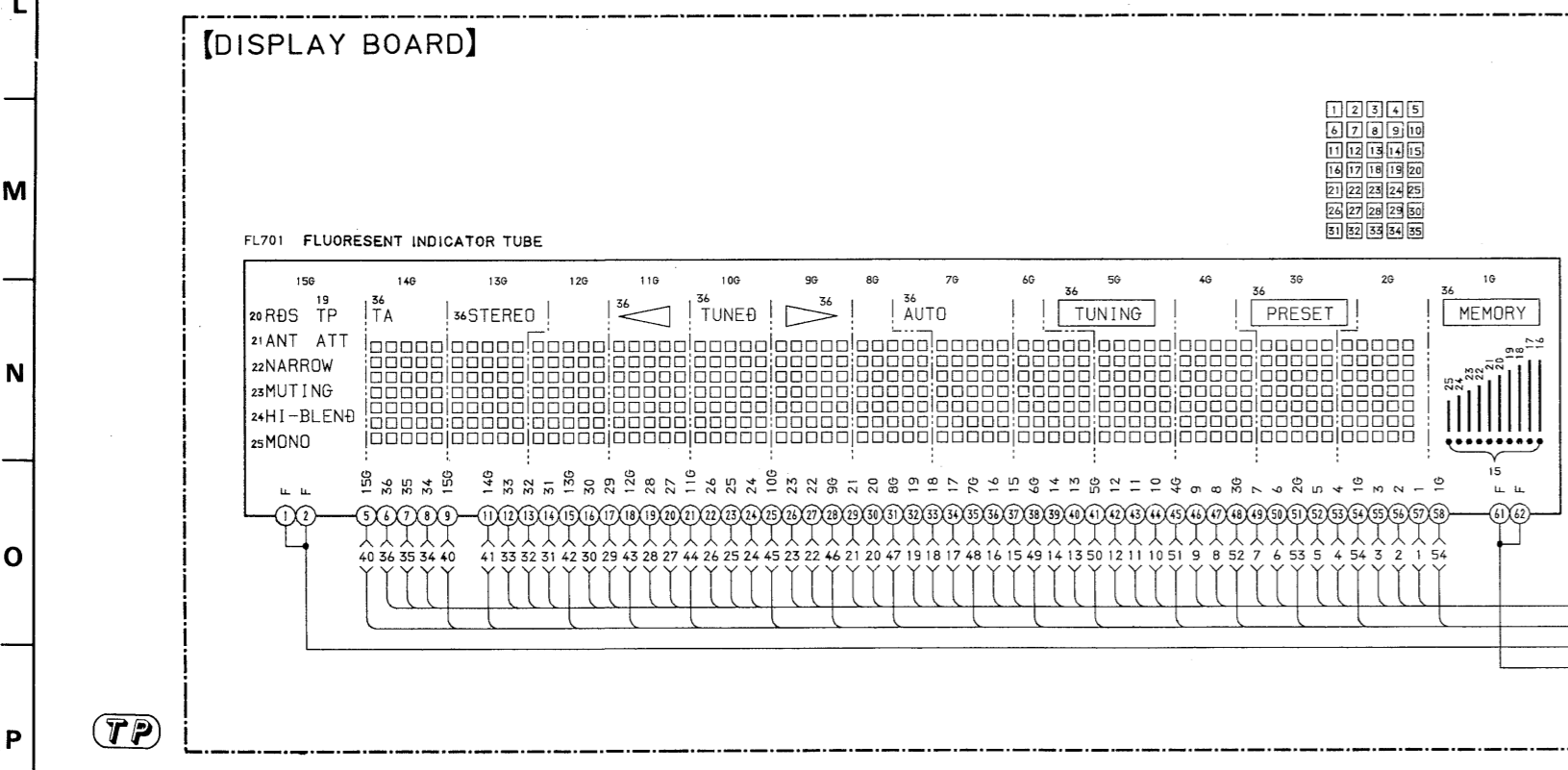
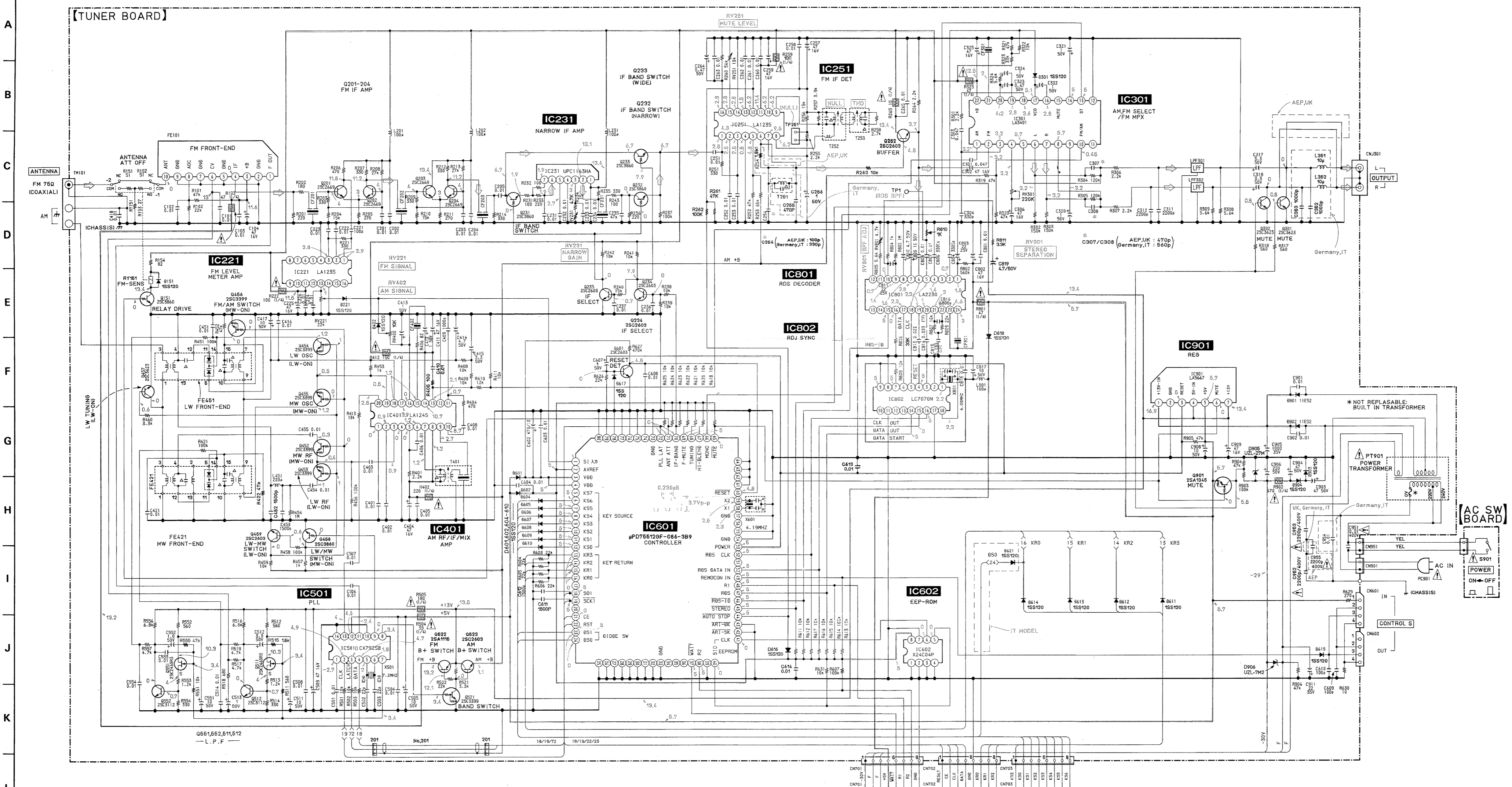

Note:

- All capacitors are in  $\mu F$  unless otherwise noted.  $pF = \mu F$  50WV or less are not indicated except for electrolytics and tantalums.
- All resistors are in  $\Omega$  and  $1/4W$  or less unless otherwise specified.
- $\Delta$ : internal component.
- $\square$ : nonflammable resistor.

Note: The components identified by mark  $\Delta$  or dotted line with mark  $\square$  are critical for safety. Replace only with part number specified.



## SECTION 4 EXPLODED VIEWS

**NOTE:**

- -XX, -X mean standardized parts, so they may have some differences from the original one.
- The construction parts of an assembled part are indicated with a collation number in the remark column.
- Color indication of Appearance Parts  
Example:  
KNOB, BALANCE (WHITE)...(RED)

↑                    ↑  
Parts color    Cabinet's color

- Items marked "\*" are not stocked since they are seldom required for routine service. Some delay should be anticipated when ordering these items.
- The mechanical parts with no reference number in the exploded views are not supplied.

The components identified by mark or dotted line with mark are critical for safety. Replace only with part number specified.

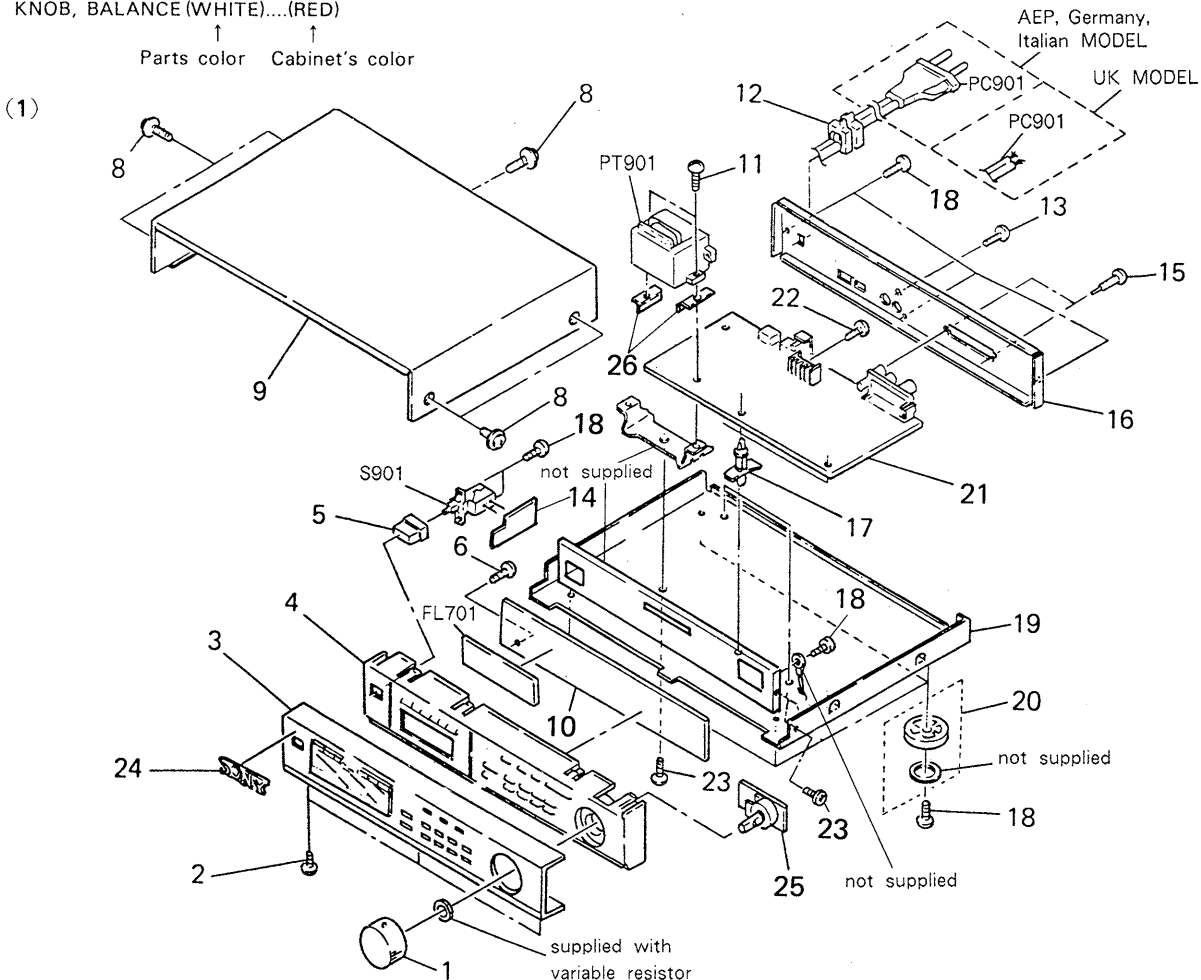

Ref. No.	Part No.	Description	Remark	Ref. No.	Part No.	Description	Remark
1	4-944-125-01	KNOB (DIA. 44)		17	* 3-346-265-11	HOLDER, PC BOARD	
2	7-682-547-04	SCREW +BV 3X6, S TIGHT (AEP, UK, Germany)		18	7-685-646-79	SCREW +BVTP 3X8 TYPE2 N-S	
3	4-945-288-01	PANEL, FRONT		19	* 4-929-296-51	CHASSIS	
4	X-4941-623-1	PANEL (BASE) ASSY		20	X-3304-944-1	FOOT ASSY	
5	3-354-912-01	KNOB, POWER		21	* A-4345-157-A	TUNER BOARD, COMPLETE (AEP)	
6	4-928-635-01	SCREW, +BV (2.6X8) TAPPING		21	* A-4345-158-A	TUNER BOARD, COMPLETE (Germany)	
8	3-704-366-01	SCREW (CASE) (M3X8)		21	* A-4345-159-A	TUNER BOARD, COMPLETE (UK)	
9	4-923-457-01	CASE		21	* A-4345-160-A	TUNER BOARD, COMPLETE (Italian)	
10	* A-4345-104-A	DISPLAY BOARD, COMPLETE		22	7-682-548-04	SCREW +BVTT 3X8 (S)	
11	7-682-550-04	SCREW +BVTT 3X12 (S)		23	7-682-547-09	SCREW +BVTT 3X6 (S)	
12	* 3-703-244-00	BUSHING (2104), CORD		24	4-908-848-01	EMBLEM, SONY	
13	7-621-849-00	SCREW (BV/RING)		25	* 1-640-344-11	ENCODER BOARD	
14	* 1-640-342-11	AC SW BOARD		26	4-947-591-01	INSULATOR	
15	3-704-242-01	SCREW, TERMINAL, + BVTP CLAW		FL701	1-519-643-11	INDICATOR TUBE, FLUORESCENT	
16	* 4-945-296-11	PANEL, BACK (AEP, Italian)		PC901	1-575-651-11	CORD, POWER (AEP, Germany, Italian)	
16	* 4-945-296-21	PANEL, BACK (Germany)		PC901	1-575-652-11	CORD, POWER (UK)	
16	* 4-945-296-32	PANEL, BACK (UK)		PT901	1-450-408-11	POWER TRANSFORMER	
				S901	1-572-267-11	SWITCH, PUSH (AC POWER) (1 KEY)	

## SECTION 5 ELECTRICAL PARTS LIST

### AC SW

### DISPLAY

### ENCODER

**NOTE:**

- Due to standardization, replacements in the parts list may be different from the parts specified in the diagrams or the components used on the set.
- -XX, -X mean standardized parts, so they may have some difference from the original one.
- RESISTORS  
All resistors are in ohms  
METAL: Metal-film resistor  
METAL OXIDE: Metal Oxide-film resistor  
F: nonflammable

- Items marked "\*" are not stocked since they are seldom required for routine service. Some delay should be anticipated when ordering these items.
- SEMICONDUCTORS  
In each case, u:  $\mu$ , for example:  
uA.....:  $\mu$ A....., uPA.....:  $\mu$ PA.....  
uPB.....:  $\mu$ PB....., uPC.....:  $\mu$ PC.....  
uPD.....:  $\mu$ PD.....
- CAPACITORS  
uF:  $\mu$ F
- COILS  
uH:  $\mu$ H

The components identified by mark  $\Delta$  or dotted line with mark  $\Delta$  are critical for safety. Replace only with part number specified.

When indicating parts by reference number, please include the board name.

Ref. No.	Part No.	Description	Remark
	* 1-640-342-11	AC SW BOARD ***** < SWITCH >	
S901	$\Delta$ 1-572-267-51	SWITCH, PUSH (AC POWER) (1 KEY)	
*****			
	* A-4345-104-A	DISPLAY BOARD, COMPLETE *****	
	* 4-945-292-01	HOLDER, INDICATION TUBE  < CAPACITOR >	
C701	1-162-210-31	CERAMIC 30PF 5% 50V	
C702	1-164-096-11	CERAMIC 0.01uF 50V	
C703	1-126-177-11	ELECT 100uF 20% 10V	
C704	1-161-379-00	CERAMIC 0.01uF 20% 25V	
C705	1-164-096-11	CERAMIC 0.01uF 50V	
C706	1-161-379-00	CERAMIC 0.01uF 20% 25V	
< DIODE >			
D701	8-719-301-52	DIODE SEL2810A-C (WAIT)	
< FILTER >			
FL701	1-519-643-11	INDICATOR TUBE, FLUORESCENT	
< IC >			
IC701	8-759-823-57	IC LC75711E	
< RESISTOR >			
R701	1-249-436-11	CARBON 39K 5% 1/4W	
R702	$\Delta$ 1-249-401-11	CARBON 47 5% 1/4W	
R703	$\Delta$ 1-249-413-11	CARBON 470 5% 1/4W	

Ref. No.	Part No.	Description	Remark
< SWITCH >			
S701	1-572-198-11	SWITCH, KEY BOARD (1)	
S702	1-572-198-11	SWITCH, KEY BOARD (2)	
S703	1-572-198-11	SWITCH, KEY BOARD (3)	
S704	1-572-198-11	SWITCH, KEY BOARD (4)	
S705	1-572-198-11	SWITCH, KEY BOARD (5)	
S706	1-572-198-11	SWITCH, KEY BOARD (6)	
S707	1-572-198-11	SWITCH, KEY BOARD (7)	
S708	1-572-198-11	SWITCH, KEY BOARD (8)	
S709	1-572-198-11	SWITCH, KEY BOARD (9)	
S710	1-572-198-11	SWITCH, KEY BOARD (0)	
S711	1-572-198-11	SWITCH, KEY BOARD (SHIFT)	
S712	1-572-198-11	SWITCH, KEY BOARD (BAND)	
S713	1-572-198-11	SWITCH, KEY BOARD (DILECT)	
S714	1-572-198-11	SWITCH, KEY BOARD (TUNING PRESET)	
S715	1-572-198-11	SWITCH, KEY BOARD (TUNING MODE)	
S716	1-572-198-11	SWITCH, KEY BOARD (MEMORY)	
S717	1-572-198-11	SWITCH, KEY BOARD (ANT ATT)	
S718	1-572-198-11	SWITCH, KEY BOARD (1F BAND)	
S721	1-572-198-11	SWITCH, KEY BOARD (STEREO/MUTE)	
S722	1-572-198-11	SWITCH, KEY BOARD (CHARECTOR)	
S723	1-572-198-11	SWITCH, KEY BOARD (DISPLAY)	
S724	1-572-198-11	SWITCH, KEY BOARD (DISPLAY MODE)	
S725	1-572-198-11	SWITCH, KEY BOARD (RDS)	
S726	1-572-198-11	SWITCH, KEY BOARD (AF)	
*****			
	* 1-640-344-11	ENCODER BOARD *****  < VARIABLE RESISTOR >	
RV701	1-466-513-11	ENCODER, ROTARY (TUNING/CHARACTER)	



## TUNER

Ref. No.	Part No.	Description	Remark	Ref. No.	Part No.	Description	Remark
	* A-4345-157-A	TUNER BOARD, COMPLETE (AEP)		C265	1-161-379-00	CERAMIC	0.01uF 20% 25V
	* A-4345-158-A	TUNER BOARD, COMPLETE (Germany)		C301	1-164-098-11	CERAMIC	0.047uF 12V
	* A-4345-159-A	TUNER BOARD, COMPLETE (UK)		C302	1-124-477-11	ELECT	47uF 20% 25V
	* A-4345-160-A	TUNER BOARD, COMPLETE (Italian)		C303	1-164-098-11	CERAMIC	0.047uF 12V
		*****		C304	1-162-288-31	CERAMIC	330PF 10% 50V
	1-690-122-41	REED (WITH CONNECTOR) (2 CORE)		C306	1-124-477-11	ELECT	47uF 20% 25V
	7-682-548-04	SCREW +BVTT 3X8 (S)		C307	1-130-467-00	MYLAR	470PF 5% 50V (AEP, UK)
		< CAPACITOR >		C307	1-130-468-00	MYLAR	560PF 5% 50V (Germany, Italian)
C101	1-161-379-00	CERAMIC	0.01uF 20% 25V	C308	1-130-467-00	MYLAR	470PF 5% 50V (AEP, UK)
C102	1-161-379-00	CERAMIC	0.01uF 20% 25V	C308	1-130-468-00	MYLAR	560PF 5% 50V (Germany, Italian)
C103	1-161-379-00	CERAMIC	0.01uF 20% 25V	C311	1-161-375-00	CERAMIC	0.0022uF 20% 50V
C104	1-124-477-11	ELECT	47uF 20% 25V	C312	1-161-375-00	CERAMIC	0.0022uF 20% 50V
C201	1-161-379-00	CERAMIC	0.01uF 20% 25V	C317	1-123-382-00	ELECT	3.3uF 20% 100V
C202	1-161-379-00	CERAMIC	0.01uF 20% 25V	C318	1-123-382-00	ELECT	3.3uF 20% 100V
C203	1-161-379-00	CERAMIC	0.01uF 20% 25V	C320	1-124-903-11	ELECT	1uF 20% 50V
C204	1-161-379-00	CERAMIC	0.01uF 20% 25V	C321	1-124-903-11	ELECT	1uF 20% 50V
C205	1-161-379-00	CERAMIC	0.01uF 20% 25V	C322	1-124-903-11	ELECT	1uF 20% 50V
C221	1-162-282-31	CERAMIC	100PF 10% 50V	C323	1-124-902-00	ELECT	0.47uF 20% 50V
C222	1-161-379-00	CERAMIC	0.01uF 20% 25V	C324	1-124-903-11	ELECT	1uF 20% 50V
C223	1-161-379-00	CERAMIC	0.01uF 20% 25V	C325	1-124-477-11	ELECT	47uF 20% 25V
C224	1-161-379-00	CERAMIC	0.01uF 20% 25V	C352	1-162-294-31	CERAMIC	0.001uF 10% 50V (Germany, Italian)
C225	1-124-477-11	ELECT	47uF 20% 25V	C353	1-162-294-31	CERAMIC	0.001uF 10% 50V (Germany, Italian)
C226	1-161-379-00	CERAMIC	0.01uF 20% 25V	C401	1-161-379-00	CERAMIC	0.01uF 20% 25V
C231	1-161-379-00	CERAMIC	0.01uF 20% 25V	C402	1-161-379-00	CERAMIC	0.01uF 20% 25V
C232	1-161-379-00	CERAMIC	0.01uF 20% 25V	C403	1-161-379-00	CERAMIC	0.01uF 20% 25V
C233	1-161-379-00	CERAMIC	0.01uF 20% 25V	C404	1-124-477-11	ELECT	47uF 20% 25V
C234	1-161-379-00	CERAMIC	0.01uF 20% 25V	C405	1-161-379-00	CERAMIC	0.01uF 20% 25V
C235	1-162-215-31	CERAMIC	47PF 5% 50V	C406	1-161-379-00	CERAMIC	0.01uF 20% 25V
C236	1-161-379-00	CERAMIC	0.01uF 20% 25V	C408	1-161-379-00	CERAMIC	0.01uF 20% 25V
C237	1-161-379-00	CERAMIC	0.01uF 20% 25V	C409	1-162-294-31	CERAMIC	0.001uF 10% 50V
C251	1-161-379-00	CERAMIC	0.01uF 20% 25V	C410	1-161-379-00	CERAMIC	0.01uF 20% 25V
C252	1-161-379-00	CERAMIC	0.01uF 20% 25V	C411	1-124-477-11	ELECT	47uF 20% 25V
C253	1-161-379-00	CERAMIC	0.01uF 20% 25V	C412	1-124-903-11	ELECT	1uF 20% 50V
C254	1-162-282-31	CERAMIC	100PF 10% 50V (AEP, UK)	C413	1-124-903-11	ELECT	1uF 20% 50V
C254	1-162-288-31	CERAMIC	330PF 10% 50V (Germany, Italian)	C414	1-124-927-11	ELECT	4.7uF 20% 100V
C255	1-162-290-31	CERAMIC	470PF 10% 50V (Germany, Italian)	C415	1-123-382-00	ELECT	3.3uF 20% 100V
C256	1-124-903-11	ELECT	1uF 20% 50V	C416	1-161-379-00	CERAMIC	0.01uF 20% 25V
C257	1-124-477-11	ELECT	47uF 20% 25V	C417	1-124-907-11	ELECT	10uF 20% 50V
C258	1-161-379-00	CERAMIC	0.01uF 20% 25V	C418	1-161-379-00	CERAMIC	0.01uF 20% 25V
C259	1-124-477-11	ELECT	47uF 20% 25V	C421	1-161-379-00	CERAMIC	0.01uF 20% 25V
C260	1-161-379-00	CERAMIC	0.01uF 20% 25V	C451	1-161-379-00	CERAMIC	0.01uF 20% 25V
C261	1-161-379-00	CERAMIC	0.01uF 20% 25V	C452	1-161-374-11	CERAMIC	0.0015uF 20% 50V
C262	1-161-379-00	CERAMIC	0.01uF 20% 25V				
C263	1-161-379-00	CERAMIC	0.01uF 20% 25V				
C264	1-124-902-00	ELECT	0.47uF 20% 50V				

## TUNER

Ref. No.	Part No.	Description		Remark	
C453	1-161-374-11	CERAMIC	0.0015uF	20%	50V
C454	1-161-379-00	CERAMIC	0.01uF	20%	25V
C455	1-161-379-00	CERAMIC	0.01uF	20%	25V
C501	1-161-379-00	CERAMIC	0.01uF	20%	25V
C502	1-102-959-00	CERAMIC	22PF	5%	50V
C503	1-102-959-00	CERAMIC	22PF	5%	50V
C504	1-161-379-00	CERAMIC	0.01uF	20%	25V
C505	1-124-907-11	ELECT	10uF	20%	50V
C506	1-161-379-00	CERAMIC	0.01uF	20%	25V
C507	1-161-379-00	CERAMIC	0.01uF	20%	25V
C508	1-161-379-00	CERAMIC	0.01uF	20%	25V
C509	1-124-477-11	ELECT	47uF	20%	25V
C511	1-124-907-11	ELECT	10uF	20%	50V
C512	1-123-382-00	ELECT	3.3uF	20%	100V
C513	1-124-903-11	ELECT	1uF	20%	50V
C514	1-161-379-00	CERAMIC	0.01uF	20%	25V
C551	1-124-907-11	ELECT	10uF	20%	50V
C552	1-124-903-11	ELECT	1uF	20%	50V
C553	1-161-379-00	CERAMIC	0.01uF	20%	25V
C554	1-161-379-00	CERAMIC	0.01uF	20%	25V
C602	1-124-472-11	ELECT	470uF	20%	10V
C603	1-161-379-00	CERAMIC	0.01uF	20%	25V
C604	1-161-379-00	CERAMIC	0.01uF	20%	25V
C607	1-124-903-11	ELECT	1uF	20%	50V
C608	1-161-379-00	CERAMIC	0.01uF	20%	25V
C609	1-162-282-31	CERAMIC	100PF	10%	50V
C610	1-162-282-31	CERAMIC	100PF	10%	50V
C611	1-161-374-11	CERAMIC	0.0015uF	20%	50V
C612	1-161-374-11	CERAMIC	0.0015uF	20%	50V
C613	1-161-379-00	CERAMIC	0.01uF	20%	25V
C614	1-161-379-00	CERAMIC	0.01uF	20%	25V
C801	1-161-379-00	CERAMIC	0.01uF	20%	25V
C802	1-124-477-11	ELECT	47uF	20%	25V
C803	1-126-233-11	ELECT	22uF	20%	50V
C804	1-161-327-00	CERAMIC	0.0033uF	30%	16V
C806	1-161-327-00	CERAMIC	0.0033uF	30%	16V
C807	1-161-379-00	CERAMIC	0.01uF	20%	25V
C808	1-161-379-00	CERAMIC	0.01uF	20%	25V
C809	1-124-907-11	ELECT	10uF	20%	50V
C810	1-124-927-11	ELECT	4.7uF	20%	100V
C811	1-124-907-11	ELECT	10uF	20%	50V
C813	1-164-097-11	CERAMIC	0.022uF		50V
C814	1-136-159-00	FILM	0.033uF	5%	50V
C815	1-136-159-00	FILM	0.033uF	5%	50V
C816	1-161-329-00	CERAMIC	0.0068uF	30%	16V
C817	1-124-907-11	ELECT	10uF	20%	50V
C818	1-161-379-00	CERAMIC	0.01uF	20%	25V
C819	1-124-927-11	ELECT	4.7uF	20%	100V
C901	1-101-004-00	CERAMIC	0.01uF		50V

Ref. No.	Part No.	Description		Remark	
C902	1-101-004-00	CERAMIC	0.01uF		50V
C903	1-124-910-11	ELECT	47uF	20%	50V
C904	1-124-910-11	ELECT	47uF	20%	50V
C905	1-126-105-11	ELECT	1000uF	20%	35V
C906	1-124-911-11	ELECT	220uF	20%	50V
C908	1-124-907-11	ELECT	10uF	20%	50V
C909	1-124-477-11	ELECT	47uF	20%	25V
C911	1-126-233-11	ELECT	22uF	20%	50V
C951	△ 1-161-744-00	CERAMIC	0.01uF		400V
C952	△ 1-161-742-00	CERAMIC	0.0022uF	20%	400V
C953	△ 1-161-742-00	CERAMIC	0.0022uF	20%	400V
C954	1-101-004-00	CERAMIC	0.01uF		50V
C955	△ 1-161-742-00	CERAMIC	0.0022uF	20%	400V
(Germany, Italian)					
(AEP)					
< FILTER >					
CF201	1-567-389-11	FILTER, CERAMIC			
CF202	1-567-389-11	FILTER, CERAMIC			
CF203	1-567-389-11	FILTER, CERAMIC			
CF231	1-567-107-71	FILTER, CERAMIC			
CF301	1-567-250-11	OSCILLATOR, CERAMIC			
CF402	1-527-981-00	FILTER, CERAMIC			
CF801	1-577-075-11	OSCILLATOR, CERAMIC			
< CONNECTOR >					
CN601	1-564-980-11	PIN, CONNECTOR 4P (CONTROL-S IN)			
CN602	1-564-980-11	PIN, CONNECTOR 4P (CONTROL-S OUT)			
CN701	* 1-564-342-11	PIN, CONNECTOR 8P			
CN702	* 1-564-342-61	PIN, CONNECTOR 8P			
CN703	* 1-564-342-11	PIN, CONNECTOR 8P			
CN901	* 1-564-321-00	PIN, CONNECTOR 2P			
CN951	1-564-321-00	PIN, CONNECTOR 2P			
CNJ301	1-568-250-11	JACK, PIN 2P (PUTPUT)			
< DIODE >					
D151	8-719-912-20	DIODE 1SS120			
D221	8-719-912-20	DIODE 1SS120			
D301	8-719-912-20	DIODE 1SS120			
D402	8-719-912-20	DIODE 1SS120			
D601	8-719-912-20	DIODE 1SS120			
D602	8-719-912-20	DIODE 1SS120			
D604	8-719-912-20	DIODE 1SS120			
D605	8-719-912-20	DIODE 1SS120			
D606	8-719-912-20	DIODE 1SS120			
D607	8-719-912-20	DIODE 1SS120			
D608	8-719-912-20	DIODE 1SS120			
D609	8-719-912-20	DIODE 1SS120			
D610	8-719-912-20	DIODE 1SS120			
D611	8-719-912-20	DIODE 1SS120			

Note: The components identified by mark △ or dotted line with mark △ are critical for safety. Replace only with part number specified.

## TUNER

Ref. No.	Part No.	Description	Remark	Ref. No.	Part No.	Description	Remark
D612	8-719-912-20	DIODE 1SS120				< TRANSFORMER >	
D613	8-719-912-20	DIODE 1SS120					
D614	8-719-912-20	DIODE 1SS120		PT901	△ 1-450-408-11	TRANSFORMER, POWER	
D615	8-719-912-20	DIODE 1SS120				< TRANSISTOR >	
D616	8-719-912-20	DIODE 1SS120					
D617	8-719-912-20	DIODE 1SS120		Q151	8-729-904-39	TRANSISTOR DTC114TS	
D618	8-719-912-20	DIODE 1SS120		Q201	8-729-230-XX	TRANSISTOR 2SC2669-OY	
D621	8-719-912-20	DIODE 1SS120 (Italian)		Q202	8-729-230-XX	TRANSISTOR 2SC2669-OY	
D901	8-719-200-82	DIODE 11ES2		Q203	8-729-230-XX	TRANSISTOR 2SC2669-OY	
D902	8-719-200-82	DIODE 11ES2		Q204	8-729-230-XX	TRANSISTOR 2SC2669-OY	
D903	8-719-912-20	DIODE 1SS120		Q231	8-729-904-39	TRANSISTOR 2SC3860-TP	
D904	8-719-912-20	DIODE 1SS120		Q232	8-729-904-39	TRANSISTOR DTC114TS	
D905	8-719-934-18	DIODE HZS27-2L		Q233	8-729-904-39	TRANSISTOR DTC114TS	
D906	8-719-933-47	DIODE HZS7B2L		Q234	8-729-620-05	TRANSISTOR 2SC2603-EF	
		< FRONT END >		Q235	8-729-620-05	TRANSISTOR 2SC2603-EF	
FE101	1-463-857-11	FRONT END (FM) (Germany, Italian)		Q252	8-729-620-05	TRANSISTOR 2SC2603-EF	
FE101	1-465-219-11	FRONT END (AEP, UK)		Q301	8-729-141-30	TRANSISTOR 2SC3623A-LK	
		< ENCAPSULATED COMPONENT >		Q302	8-729-141-30	TRANSISTOR 2SC3623A-LK	
FE421	1-236-462-11	ENCAPSULATED COMPONENT (MW)		Q452	8-729-900-89	TRANSISTOR DTC144ES	
FE451	1-236-463-11	ENCAPSULATED COMPONENT (LW)		Q453	8-729-900-89	TRANSISTOR DTC144ES	
		< IC >		Q454	8-729-900-89	TRANSISTOR DTC144ES	
IC221	8-759-812-35	IC LA1235		Q455	8-729-900-89	TRANSISTOR DTC144ES	
IC231	8-759-111-72	IC uPC1163HA		Q456	8-729-900-89	TRANSISTOR DTC144ES	
IC251	8-759-812-35	IC LA1235		Q457	8-729-141-30	TRANSISTOR 2SC3623A-LK	
IC301	8-759-801-80	IC LA3401		Q458	8-729-904-39	TRANSISTOR 2SC3860	
IC401	8-759-812-45	IC LA1245		Q459	8-729-620-05	TRANSISTOR 2SC2603-EF	
IC501	8-757-925-20	IC CX-7925B		Q511	8-729-202-67	TRANSISTOR 2SK246-GR3	
IC601	8-759-153-09	IC uPD755126F-086-3B9		Q512	8-729-201-84	TRANSISTOR 2SC3112-B	
IC602	8-759-720-89	IC X24C04P		Q521	8-729-900-89	TRANSISTOR DTC144ES	
IC801	8-759-823-61	IC LA2230		Q522	8-729-119-76	TRANSISTOR 2SA1175-HFE	
IC802	8-759-823-62	IC LC7070N		Q523	8-729-620-05	TRANSISTOR 2SC2603-EF	
IC901	8-759-820-09	IC LA5667		Q551	8-729-202-67	TRANSISTOR 2SK246-GR3	
		< COIL >		Q552	8-729-201-84	TRANSISTOR 2SC3112-B	
L201	1-408-421-00	INDUCTOR 100uH		Q601	8-729-620-05	TRANSISTOR 2SC2603-EF	
L202	1-408-421-00	INDUCTOR 100uH		Q901	8-729-900-65	TRANSISTOR DTA144ES	
L231	1-408-421-00	INDUCTOR 100uH				< RESISTOR >	
L351	1-410-470-11	INDUCTOR 10uH (Germany, Italian)		R101	1-249-437-11	CARBON 47K 5% 1/4W	
L352	1-410-470-11	INDUCTOR 10uH (Germany, Italian)		R102	1-249-433-11	CARBON 22K 5% 1/4W	
L451	1-408-425-00	INDUCTOR 220uH		R103	△ 1-249-401-11	CARBON 47 5% 1/4W	
L801	1-408-421-00	INDUCTOR 100uH		R151	1-247-800-11	CARBON 51 5% 1/4W	
		< FILTER >		R152	1-247-800-11	CARBON 51 5% 1/4W	
LPF301	1-235-164-00	FILTER, LOW PASS		R153	1-249-398-11	CARBON 27 5% 1/4W	
LPF302	1-235-164-00	FILTER, LOW PASS		R154	1-249-404-00	CARBON 82 5% 1/4W	
				R201	1-249-409-11	CARBON 220 5% 1/4W	
				R202	1-249-408-11	CARBON 180 5% 1/4W	
				R203	1-249-411-11	CARBON 330 5% 1/4W	
				R204	1-249-431-11	CARBON 15K 5% 1/4W	

Note: The components identified by mark △ or dotted line with mark △ are critical for safety. Replace only with part number specified.

## TUNER

Ref. No.	Part No.	Description	Remark			Ref. No.	Part No.	Description	Remark		
R205	1-249-410-11	CARBON	270	5%	1/4W	R309	1-249-426-11	CARBON	5.6K	5%	1/4W
R206	1-249-413-11	CARBON	470	5%	1/4W	R317	1-249-414-11	CARBON	560	5%	1/4W
R207	1-249-411-11	CARBON	330	5%	1/4W	R318	1-249-414-11	CARBON	560	5%	1/4W
R208	1-249-434-11	CARBON	27K	5%	1/4W	R319	1-249-437-11	CARBON	47K	5%	1/4W
R209	1-249-411-11	CARBON	330	5%	1/4W	R320	1-249-437-11	CARBON	47K	5%	1/4W
R210	1-249-431-11	CARBON	15K	5%	1/4W	R321	1-249-437-11	CARBON	47K	5%	1/4W
R211	1-249-410-11	CARBON	270	5%	1/4W	R322	1-249-429-11	CARBON	10K	5%	1/4W
R212	1-249-411-11	CARBON	330	5%	1/4W	R323	1-249-435-11	CARBON	33K	5%	1/4W
R213	1-249-434-11	CARBON	27K	5%	1/4W	R324	1-249-426-11	CARBON	5.6K	5%	1/4W
R214	1-249-411-11	CARBON	330	5%	1/4W	R325	△ 1-249-401-11	CARBON	47	5%	1/4W
R221	△ 1-249-411-11	CARBON	330	5%	1/4W	R401	1-249-421-11	CARBON	2.2K	5%	1/4W
R222	1-249-405-11	CARBON	100	5%	1/4W	R402	△ 1-249-409-11	CARBON	220	5%	1/4W
R231	1-249-405-11	CARBON	100	5%	1/4W	R404	1-249-413-11	CARBON	470	5%	1/4W
R232	1-249-405-11	CARBON	100	5%	1/4W	R405	1-249-405-11	CARBON	100	5%	1/4W
R233	1-249-409-11	CARBON	220	5%	1/4W	R406	1-249-404-00	CARBON	82	5%	1/4W
R234	1-249-395-11	CARBON	15	5%	1/4W	R408	1-249-429-11	CARBON	10K	5%	1/4W
R235	1-249-411-11	CARBON	330	5%	1/4W	R409	1-249-429-11	CARBON	10K	5%	1/4W
R236	1-249-409-11	CARBON	220	5%	1/4W	R410	1-249-430-11	CARBON	12K	5%	1/4W
R237	1-249-441-11	CARBON	100K	5%	1/4W	R411	1-249-429-11	CARBON	10K	5%	1/4W
R238	1-249-429-11	CARBON	10K	5%	1/4W	R412	△ 1-249-407-11	CARBON	150	5%	1/4W
R239	1-249-429-11	CARBON	10K	5%	1/4W	R413	1-249-429-11	CARBON	10K	5%	1/4W
R240	1-249-431-11	CARBON	15K	5%	1/4W	R421	1-249-441-11	CARBON	100K	5%	1/4W
R241	1-249-429-11	CARBON	10K	5%	1/4W	R422	1-249-437-11	CARBON	47K	5%	1/4W
R242	1-249-429-11	CARBON	10K	5%	1/4W	R451	1-249-441-11	CARBON	100K	5%	1/4W
R243	1-249-405-11	CARBON	100	5%	1/4W	R452	1-249-437-11	CARBON	47K	5%	1/4W
R251	1-249-411-11	CARBON	330	5%	1/4W	R453	1-249-417-11	CARBON	1K	5%	1/4W
R252	1-249-437-11	CARBON	47K	5%	1/4W	R454	1-247-903-00	CARBON	1M	5%	1/4W
R253	1-249-439-11	CARBON	68K	5%	1/4W	R456	1-249-441-11	CARBON	100K	5%	1/4W
R254	1-249-420-11	CARBON	1.8K	5%	1/4W	R457	1-249-417-11	CARBON	1K	5%	1/4W
					(Germany, Italian)	R458	1-249-441-11	CARBON	100K	5%	1/4W
R255	1-249-421-11	CARBON	2.2K	5%	1/4W	R459	1-249-429-11	CARBON	10K	5%	1/4W
R256	1-249-431-11	CARBON	15K	5%	1/4W	R460	1-249-423-11	CARBON	3.3K	5%	1/4W
R257	1-249-424-11	CARBON	3.9K	5%	1/4W	R501	1-249-429-11	CARBON	10K	5%	1/4W
R258	1-249-422-11	CARBON	2.7K	5%	1/4W	R502	1-249-429-11	CARBON	10K	5%	1/4W
R259	1-249-405-11	CARBON	100	5%	1/4W	R503	1-249-429-11	CARBON	10K	5%	1/4W
R260	1-249-438-11	CARBON	56K	5%	1/4W	R504	△ 1-249-400-11	CARBON	39	5%	1/4W
R261	1-249-437-11	CARBON	47K	5%	1/4W	R505	△ 1-249-408-11	CARBON	180	5%	1/4W
R262	1-249-441-11	CARBON	100K	5%	1/4W	R511	1-249-414-11	CARBON	560	5%	1/4W
R263	1-249-429-11	CARBON	10K	5%	1/4W	R512	1-249-414-11	CARBON	560	5%	1/4W
R264	1-249-421-11	CARBON	2.2K	5%	1/4W	R513	1-249-418-11	CARBON	1.2K	5%	1/4W
R265	△ 1-249-393-11	CARBON	10	5%	1/4W	R514	1-249-411-11	CARBON	330	5%	1/4W
R301	1-249-421-11	CARBON	2.2K	5%	1/4W	R515	1-249-420-11	CARBON	1.8K	5%	1/4W
R302	1-247-883-00	CARBON	150K	5%	1/4W	R516	1-249-427-11	CARBON	6.8K	5%	1/4W
R303	1-247-883-00	CARBON	150K	5%	1/4W	R517	1-249-425-11	CARBON	4.7K	5%	1/4W
R304	1-247-881-00	CARBON	120K	5%	1/4W	R518	1-249-415-11	CARBON	680	5%	1/4W
R305	1-247-881-00	CARBON	120K	5%	1/4W	R519	1-249-425-11	CARBON	4.7K	5%	1/4W
R306	1-249-421-11	CARBON	2.2K	5%	1/4W	R521	1-249-423-11	CARBON	3.3K	5%	1/4W
R307	1-249-421-11	CARBON	2.2K	5%	1/4W	R522	1-249-433-11	CARBON	22K	5%	1/4W
R308	1-249-426-11	CARBON	5.6K	5%	1/4W	R551	1-249-429-11	CARBON	10K	5%	1/4W

Note: The components identified by mark △ or dotted line with mark △ are critical for safety. Replace only with part number specified.

## TUNER

Ref. No.	Part No.	Description			Remark
R552	1-249-414-11	CARBON	560	5%	1/4W
R553	1-249-418-11	CARBON	1.2K	5%	1/4W
R554	1-249-411-11	CARBON	330	5%	1/4W
R555	1-249-437-11	CARBON	47K	5%	1/4W
R556	1-249-427-11	CARBON	6.8K	5%	1/4W
R557	1-249-425-11	CARBON	4.7K	5%	1/4W
R603	1-249-433-11	CARBON	22K	5%	1/4W
R604	1-249-433-11	CARBON	22K	5%	1/4W
R605	1-249-433-11	CARBON	22K	5%	1/4W
R606	1-249-433-11	CARBON	22K	5%	1/4W
R607	1-249-441-11	CARBON	100K	5%	1/4W
R611	1-249-429-11	CARBON	10K	5%	1/4W
R612	1-249-429-11	CARBON	10K	5%	1/4W
R613	1-249-429-11	CARBON	10K	5%	1/4W
R614	1-249-441-11	CARBON	100K	5%	1/4W
R615	1-249-429-11	CARBON	10K	5%	1/4W
R616	1-249-429-11	CARBON	10K	5%	1/4W
R617	1-249-429-11	CARBON	10K	5%	1/4W
R618	1-249-429-11	CARBON	10K	5%	1/4W
R620	1-249-429-11	CARBON	10K	5%	1/4W
R621	1-249-429-11	CARBON	10K	5%	1/4W
R622	1-249-429-11	CARBON	10K	5%	1/4W
R623	1-249-429-11	CARBON	10K	5%	1/4W
R624	1-249-429-11	CARBON	10K	5%	1/4W
R625	1-249-429-11	CARBON	10K	5%	1/4W
R626	1-249-433-11	CARBON	22K	5%	1/4W
R627	1-247-895-00	CARBON	470K	5%	1/4W
R629	1-249-410-11	CARBON	270	5%	1/4W
R630	1-249-393-11	CARBON	10	5%	1/4W
R631	1-249-429-11	CARBON	10K	5%	1/4W
R801	$\Delta$ 1-249-401-11	CARBON	47	5%	1/4W
R802	1-247-897-11	CARBON	560K	5%	1/4W
R803	1-247-903-00	CARBON	1M	5%	1/4W
R804	1-249-417-11	CARBON	1K	5%	1/4W
R805	1-249-426-11	CARBON	5.6K	5%	1/4W
R806	1-249-435-11	CARBON	33K	5%	1/4W
R807	1-249-429-11	CARBON	10K	5%	1/4W
R808	1-249-433-11	CARBON	22K	5%	1/4W
R809	1-249-429-11	CARBON	10K	5%	1/4W
R810	1-249-417-11	CARBON	1K	5%	1/4W
R811	1-249-423-11	CARBON	3.3K	5%	1/4W
R902	$\Delta$ 1-249-413-11	CARBON	470	5%	1/4W
R903	1-249-441-11	CARBON	100K	5%	1/4W
R904	1-249-437-11	CARBON	47K	5%	1/4W
R905	1-249-437-11	CARBON	47K	5%	1/4W
R906	1-249-437-11	CARBON	47K	5%	1/4W

Ref. No.	Part No.	Description	Remark
		< VARIABLE RESISTOR >	
RV221	1-238-601-11	RES. ADJ. CARBON 22K (FM SIGNAL)	
RV231	1-238-599-11	RES. ADJ. CARBON 4.7K (NARROW GAIN)	
RV251	1-238-600-11	RES. ADJ. CARBON 10K (FM MUTE LEVEL)	
RV301	1-238-604-11	RES. ADJ. CARBON 220K (STEREO SEPARATION)	
RV402	1-238-600-11	RES. ADJ. CARBON 10K (AM SIGNAL)	
RV801	1-238-599-11	RES. ADJ. CARBON 4.7K (RDS BPF)	
		< RELAY >	
RY151	1-515-614-11	RELAY	
		< ENCAPSULATED COMPONENT >	
T251	1-235-126-00	ENCAPSULATED COMPONENT (Germany, Italian)	
		< COIL >	
T252	1-404-845-11	COIL, DISCRI (PRIMARY) (NULL)	
T253	1-404-846-11	COIL, DISCRI (SECONDARY) (MONO DISTORTION)	
		< TRANSFORMER >	
T401	1-404-713-11	TRANSFORMER, IF (AM)	
		< TERMINAL >	
TM101	1-537-155-11	TERMINAL BOARD (ANT)	
		< TEST PIN >	
TP251	* 1-565-513-11	PIN, CONNECTOR 2P (NULL)	
		< VIBRATOR >	
X501	1-567-826-21	VIBRATOR, CRYSTAL (7.2MHz)	
X601	1-577-101-11	VIBRATOR, CERAMIC (4.19MHz)	
X801	1-577-358-21	VIBRATOR, CERAMIC (4.00MHz)	
		*****	
		MISCELLANEOUS	
		*****	
PC901	$\Delta$ 1-575-651-11	CORD, POWER (AEP, Germany, Italian)	
PC901	$\Delta$ 1-575-652-11	CORD, POWER (UK)	
S901	$\Delta$ 1-572-267-11	SWITCH, PUSH (AC POWER) (1 KEY)	

Note: The components identified by mark  $\Delta$  or dotted line with mark  $\Delta$  are critical for safety. Replace only with part number specified.

Ref. No.	Part No.	Description	Remark
		ACCESSORIES & PACKING MATERIALS *****	
	1-501-369-11	ANTENNA (AEP, UK, Italian)	
	1-501-374-11	ANTENNA, LOOP	
	1-558-233-11	CORD (WITH CONNECTOR) (SIRCS) 4P	
	1-559-533-11	CORD, CONNECTION	
*	3-704-343-01	SHEET (STANDARD), PROTECTION	
	3-753-232-11	MANUAL, INSTRUCTION (ENGLISH, FRENCH, SPANISH, ITALIAN) (AEP, UK, Italian)	
	3-753-232-41	MANUAL, INSTRUCTION (GERMAN, DUTCH, SWEDITH, PORTUGUESE) (AEP, Germany)	
*	4-930-835-01	CUSHION	
*	4-944-049-21	INDIVIDUAL CARTON	